

Basic Principles of Ship Propulsion

Contents:	Page
Introduction	3
Scope of this Paper	3
<i>Chapter 1</i>	
Ship Definitions and Hull Resistance	4
• Ship types	4
• A ship's load lines	4
• Indication of a ship's size	5
• Description of hull forms	5
• Ship's resistance	7
<i>Chapter 2</i>	
Propeller Propulsion	10
• Propeller types	10
• Flow conditions around the propeller	11
• Efficiencies	11
• Propeller dimensions	13
• Operating conditions of a propeller	15
<i>Chapter 3</i>	
Engine Layout and Load Diagrams	20
• Power functions and logarithmic scales	20
• Propulsion and engine running points	20
• Engine layout diagram	22
• Load diagram	22
• Use of layout and load diagrams – examples	25
• Influence on engine running of different types of ship resistance – plant with FP-propeller	27
• Influence of ship resistance on combinator curves – plant with CP-propeller	29
Closing Remarks	30
References	30

Basic Principles of Ship Propulsion

Introduction

For the purpose of this paper, the term "ship" is used to denote a vehicle employed to transport goods and persons from one point to another over water. Ship propulsion normally occurs with the help of a propeller, which is the term most widely used in English, although the word "screw" is sometimes seen, inter alia in combinations such as a "twin-screw" propulsion plant.

Today, the primary source of propeller power is the diesel engine, and the power requirement and rate of revolution very much depend on the ship's hull form and the propeller design. Therefore, in order to arrive at a solution that is as optimal as possible, some general knowledge is essential as to the principal ship and diesel engine parameters that influence the propulsion system.

This paper will, in particular, attempt to explain some of the most elementary terms used regarding ship types, ship's dimensions and hull forms and clarify some of the parameters pertaining to hull resistance, propeller conditions and the diesel engine's load diagram.

On the other hand, it is considered beyond the scope of this publication to give an explanation of how propulsion calculations as such are carried out, as the calculation procedure is extremely complex. The reader is referred to the specialised literature on this subject, for example as stated in "References".

Scope of this Paper

This paper is divided into three chapters which, in principle, may be considered as three separate papers but which also, with advantage, may be read in close connection to each other. Therefore, some important information mentioned in one chapter may well appear in another chapter, too.

Chapter 1, describes the most elementary terms used to define ship sizes and hull forms such as, for example, the ship's displacement, deadweight, design draught, length between perpendiculars, block coefficient, etc. Other ship terms described include the effective towing resistance, consisting of frictional, residual and air resistance, and the influence of these resistances in service.

Chapter 2, deals with ship propulsion and the flow conditions around the propeller(s). In this connection, the wake fraction coefficient and thrust deduction coefficient, etc. are mentioned.

The total power needed for the propeller is found based on the above effective towing resistance and various propeller and hull dependent efficiencies which are also described. A summary of the propulsion theory is shown in Fig. 6.

The operating conditions of a propeller according to the propeller law valid for a propeller with fixed pitch are described for free sailing in calm weather, and

followed up by the relative heavy/light running conditions which apply when the ship is sailing and subject to different types of extra resistance, like fouling, heavy sea against, etc.

Chapter 3, elucidates the importance of choosing the correct specified MCR and optimising point of the main engine, and thereby the engine's load diagram in consideration to the propeller's design point. The construction of the relevant load diagram lines is described in detail by means of several examples. Fig. 24 shows, for a ship with fixed pitch propeller, by means of a load diagram, the important influence of different types of ship resistance on the engine's continuous service rating.

Chapter 1

Ship Definitions and Hull Resistance

Ship types

Depending on the nature of their cargo, and sometimes also the way the cargo is loaded/unloaded, ships can be divided into different categories, classes, and types, some of which are mentioned in Table 1.

The three largest categories of ships are container ships, bulk carriers (for bulk goods such as grain, coal, ores, etc.) and tankers, which again can be divided into more precisely defined classes and types. Thus, tankers can be divided into oil tankers, gas tankers and chemical tankers, but there are also combinations, e.g. oil/chemical tankers.

Table 1 provides only a rough outline. In reality there are many other combinations, such as "Multi-purpose bulk container carriers", to mention just one example.

A ship's load lines

Painted halfway along the ship's side is the "Plimsoll Mark", see Fig. 1. The lines and letters of the Plimsoll Mark, which conform to the freeboard rules laid down by the IMO (International Maritime Organisation) and local authorities, indicate the depth to which the vessel may be safely loaded (the depth varies according to the season and the salinity of the water).

There are, e.g. load lines for sailing in freshwater and seawater, respectively, with further divisions for tropical conditions and summer and winter sailing. According to the international freeboard rules, the summer freeboard draught for seawater is equal to the "Scantling draught", which is the term applied to the ship's draught when dimensioning the hull.

The winter freeboard draught is less than that valid for summer because of

Category	Class	Type	
Tanker	Oil tanker	Crude (oil) Carrier	CC
		Very Large Crude Carrier	VLCC
		Ultra Large Crude Carrier	ULCC
	Gas tanker	Liquefied Natural Gas carrier	LNG
	Chemical tanker	Liquefied Petroleum Gas carrier	LPG
	OBO	Oil/Bulk/Ore carrier	OBO
Bulk carrier	Bulk carrier		
Container ship	Container ship	Container carrier	
		Roll On-Roll Off	Ro-Ro
General cargo ship	General cargo	Coaster	
Reefer	Reefer	Refrigerated cargo vessel	
Passenger ship	Ferry		
	Cruise vessel		

Table 1: Examples of ship types

the risk of bad weather whereas, on the other hand, the freeboard draught for

tropical seas is somewhat higher than the summer freeboard draught.

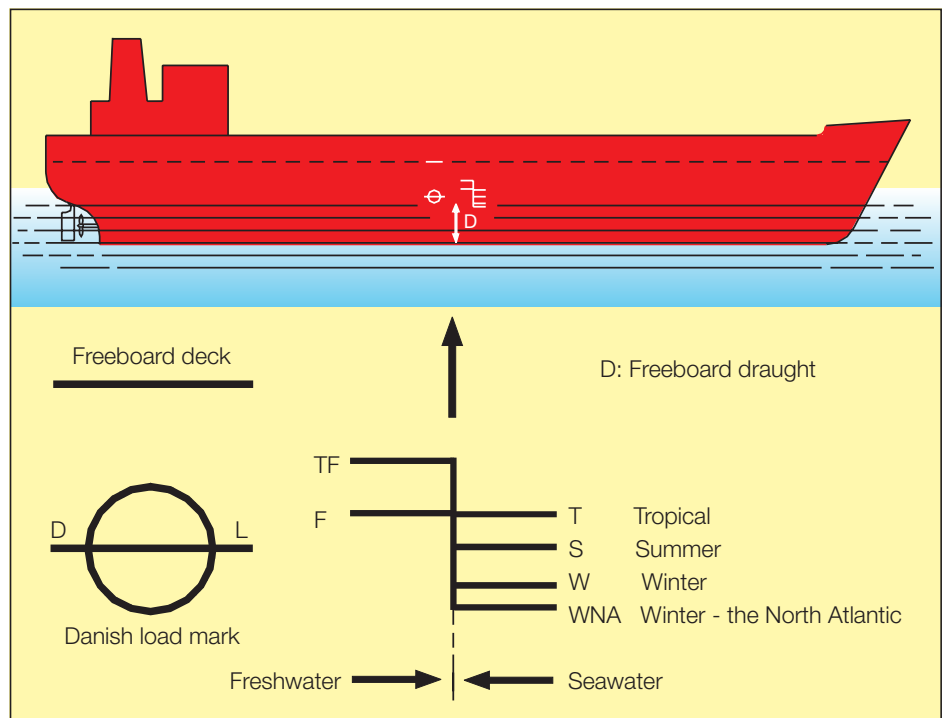

Fig. 1: Load lines – freeboard draught

Indication of a ship's size

Displacement and deadweight

When a ship in loaded condition floats at an arbitrary water line, its displacement is equal to the relevant mass of water displaced by the ship. Displacement is thus equal to the total weight, all told, of the relevant loaded ship, normally in seawater with a mass density of 1.025 t/m^3 .

Displacement comprises the ship's light weight and its deadweight, where the deadweight is equal to the ship's loaded capacity, including bunkers and other supplies necessary for the ship's propulsion. The deadweight at any time thus represents the difference between the actual displacement and the ship's light weight, all given in tons:

$$\text{deadweight} = \text{displacement} - \text{light weight}.$$

Incidentally, the word "ton" does not always express the same amount of weight. Besides the metric ton (1,000 kg), there is the English ton (1,016 kg), which is also called the "long ton". A "short ton" is approx. 907 kg.

The light weight of a ship is not normally used to indicate the size of a ship, whereas the deadweight tonnage (dwt), based on the ship's loading capacity, including fuel and lube oils etc. for operation of the ship, measured in tons at scantling draught, often is.

Sometimes, the deadweight tonnage may also refer to the design draught of the ship but, if so, this will be mentioned. Table 2 indicates the rule-of-thumb relationship between the ship's displacement, deadweight tonnage (summer freeboard/scantling draught) and light weight.

A ship's displacement can also be expressed as the volume of displaced water ∇ , i.e. in m^3 .

Gross register tons

Without going into detail, it should be mentioned that there are also such measurements as Gross Register Tons (GRT), and Net Register Tons (NRT) where 1 register ton = 100 English cubic feet, or 2.83 m^3 .

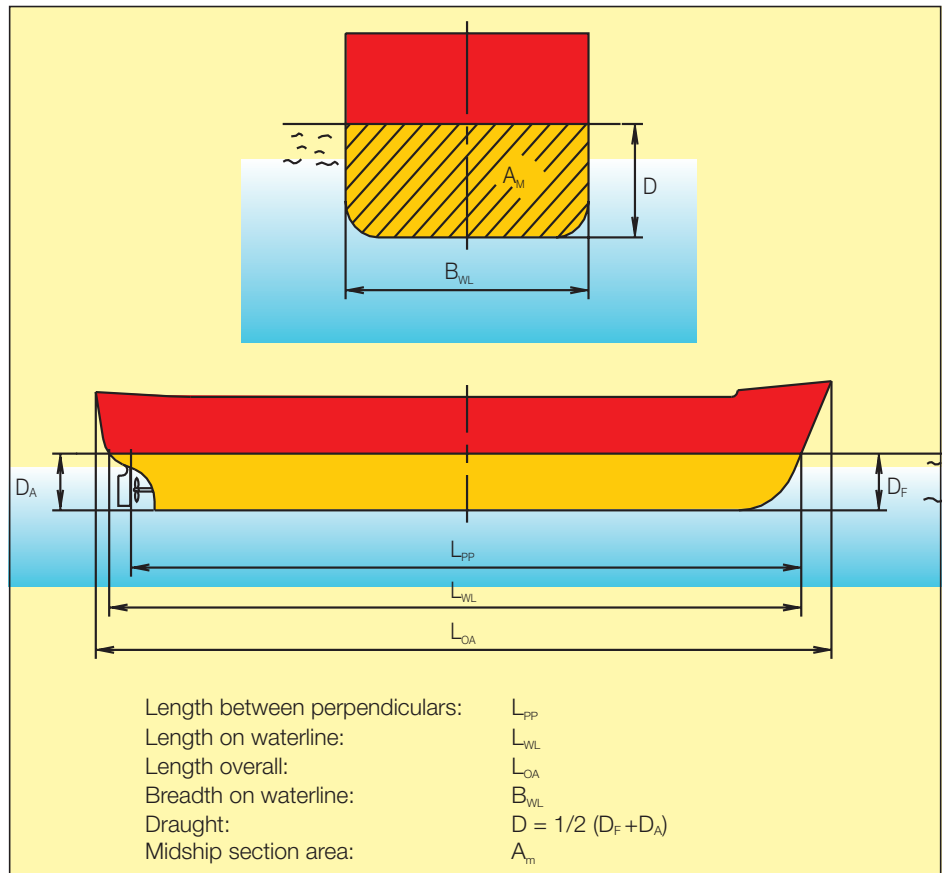

Fig. 2: Hull dimensions

Ship type	dwt/light weight ratio	Displ./dwt ratio
Tanker and Bulk carrier	6	1.17
Container ship	2.5-3.0	1.33-1.4

Table 2: Examples of relationship between displacement, deadweight tonnage and light weight

These measurements express the size of the internal volume of the ship in accordance with the given rules for such measurements, and are extensively used for calculating harbour and canal dues/charges.

Description of hull forms

It is evident that the part of the ship which is of significance for its propulsion

is the part of the ship's hull which is under the water line. The dimensions below describing the hull form refer to the design draught, which is less than, or equal to, the scantling draught. The choice of the design draught depends on the degree of load, i.e. whether, in service, the ship will be lightly or heavily loaded. Generally, the most frequently occurring draught between the fully-loaded and the ballast draught is used.

Ship's lengths L_{OA} , L_{WL} and L_{PP}
The overall length of the ship L_{OA} is normally of no consequence when calculating the hull's water resistance. The factors used are the length of the waterline L_{WL} and the so-called length between perpendiculars L_{PP} . The dimensions referred to are shown in Fig. 2.

The length between perpendiculars is the length between the foremost perpendicular, i.e. usually a vertical line through the stem's intersection with the waterline, and the aftmost perpendicular which, normally, coincides with the rudder axis. Generally, this length is slightly less than the waterline length, and is often expressed as:

$$L_{PP} = 0.97 \times L_{WL}$$

Draught D

The ship's draught D (often T is used in literature) is defined as the vertical distance from the waterline to that point of the hull which is deepest in the water, see Figs. 2 and 3. The foremost draught D_F and aftmost draught D_A are normally the same when the ship is in the loaded condition.

Breadth on waterline B_{WL}

Another important factor is the hull's largest breadth on the waterline B_{WL} , see Figs. 2 and 3.

Block coefficient C_B

Various form coefficients are used to express the shape of the hull. The most important of these coefficients is the block coefficient C_B , which is defined as the ratio between the displacement volume ∇ and the volume of a box with dimensions $L_{WL} \times B_{WL} \times D$, see Fig. 3, i.e.:

$$C_B = \frac{\nabla}{L_{WL} \times B_{WL} \times D}$$

In the case cited above, the block coefficient refers to the length on waterline L_{WL} . However, shipbuilders often use block coefficient $C_{B,PP}$ based on the length between perpendiculars, L_{PP} , in which case the block coefficient will, as a rule, be slightly larger because, as previously mentioned, L_{PP} is normally slightly less than L_{WL} .

$$C_{B,PP} = \frac{\nabla}{L_{PP} \times B_{WL} \times D}$$

A small block coefficient means less resistance and, consequently, the possibility of attaining higher speeds.

Table 3 shows some examples of block coefficient sizes, and the pertaining

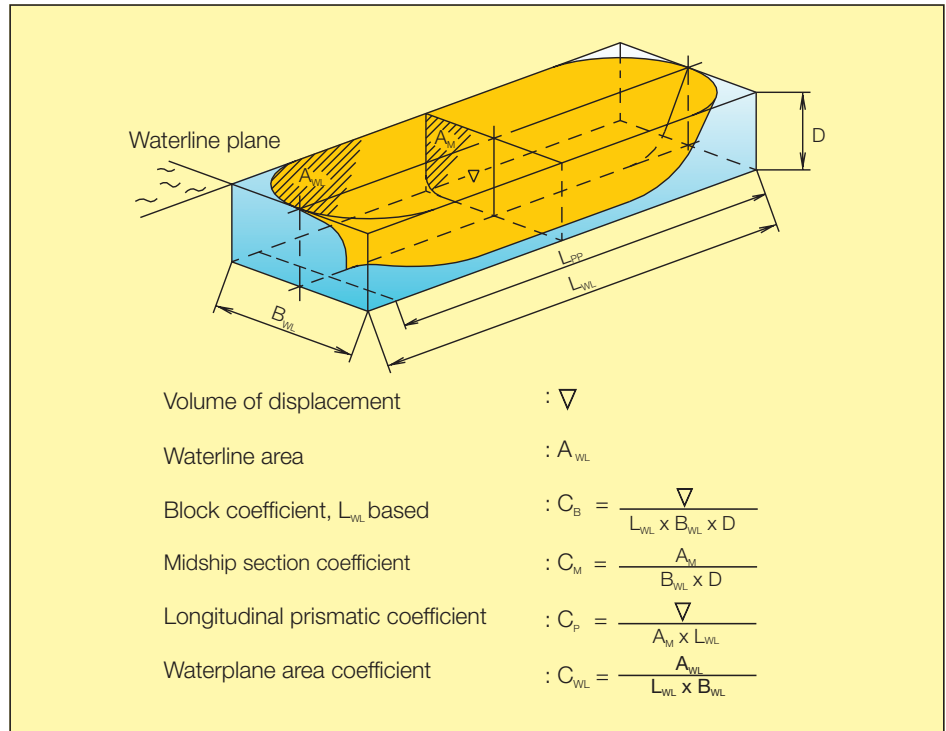

Fig. 3: Hull coefficients of a ship

service speeds, on different types of ships. It shows that large block coefficients correspond to low speeds and vice versa.

Ship type	Block coefficient C_B	Approximate ship speed V in knots
Lighter	0.90	5 – 10
Bulk carrier	0.80 – 0.85	12 – 17
Tanker	0.80 – 0.85	12 – 16
General cargo	0.55 – 0.75	13 – 22
Container ship	0.50 – 0.70	14 – 26
Ferry boat	0.50 – 0.70	15 – 26

Table 3: Examples of block coefficients

Water plane area coefficient C_{WL}

The water plane area coefficient C_{WL} expresses the ratio between the vessel's waterline area A_{WL} and the product of the length L_{WL} and the breadth B_{WL} of the ship on the waterline, see Fig. 3, i.e.:

$$C_{WL} = \frac{A_{WL}}{L_{WL} \times B_{WL}}$$

Generally, the waterplane area coefficient is some 0.10 higher than the block coefficient, i.e.:

$$C_{WL} \cong C_B + 0.10.$$

This difference will be slightly larger on fast vessels with small block coefficients where the stern is also partly immersed in the water and thus becomes part of the "waterplane" area.

Midship section coefficient C_M

A further description of the hull form is provided by the midship section coefficient C_M , which expresses the ratio between the immersed midship section area A_M (midway between the foremost and the aftmost perpendiculars) and the product of the ship's breadth B_{WL} and draught D , see Fig. 3, i.e.:

$$C_M = \frac{A_M}{B_{WL} \times D}$$

For bulkers and tankers, this coefficient is in the order of 0.98-0.99, and for container ships in the order of 0.97-0.98.

Longitudinal prismatic coefficient C_p
The longitudinal prismatic coefficient C_p expresses the ratio between displacement volume ∇ and the product of the midship frame section area A_M and the length of the waterline L_{WL} , see also Fig. 3, i.e.:

$$C_p = \frac{\nabla}{A_M \times L_{WL}} = \frac{\nabla}{C_M \times B_{WL} \times D \times L_{WL}} = \frac{C_B}{C_M}$$

As can be seen, C_p is not an independent form coefficient, but is entirely dependent on the block coefficient C_B and the midship section coefficient C_M .

Longitudinal Centre of Buoyancy LCB
The Longitudinal Centre of Buoyancy (LCB) expresses the position of the centre of buoyancy and is defined as the distance between the centre of buoyancy and the mid-point between the ship's foremost and aftmost perpendiculars. The distance is normally stated as a percentage of the length between the perpendiculars, and is positive if the centre of buoyancy is located to the fore of the mid-point between the perpendiculars, and negative if located to the aft of the mid-point. For a ship designed for high speeds, e.g. container ships, the LCB will, normally, be negative, whereas for slow-speed ships, such as tankers and bulk carriers, it will normally be positive. The LCB is generally between -3% and +3%.

Fineness ratio C_{LD}
The length/displacement ratio or fineness ratio, C_{LD} , is defined as the ratio between the ship's waterline length L_{WL} , and the length of a cube with a volume equal to the displacement volume, i.e.:

$$C_{LD} = \frac{L_{WL}}{\sqrt[3]{\nabla}}$$

Ship's resistance

To move a ship, it is first necessary to overcome resistance, i.e. the force working against its propulsion. The calculation of this resistance R plays a significant role

in the selection of the correct propeller and in the subsequent choice of main engine.

General

A ship's resistance is particularly influenced by its speed, displacement, and hull form. The total resistance R_T , consists of many source-resistances R which can be divided into three main groups, viz.:

- 1) Frictional resistance
- 2) Residual resistance
- 3) Air resistance

The influence of frictional and residual resistances depends on how much of the hull is below the waterline, while the influence of air resistance depends on how much of the ship is above the waterline. In view of this, air resistance will have a certain effect on container ships which carry a large number of containers on the deck.

Water with a speed of V and a density of ρ has a dynamic pressure of:

$$\frac{1}{2} \times \rho \times V^2 \text{ (Bernoulli's law)}$$

Thus, if water is being completely stopped by a body, the water will react on the surface of the body with the dynamic pressure, resulting in a dynamic force on the body.

This relationship is used as a basis when calculating or measuring the source-resistances R of a ship's hull, by means of dimensionless resistance coefficients C . Thus, C is related to the reference force K , defined as the force which the dynamic pressure of water with the ship's speed V exerts on a surface which is equal to the hull's wetted area A_S . The rudder's surface is also included in the wetted area. The general data for resistance calculations is thus:

Reference force: $K = \frac{1}{2} \times \rho \times V^2 \times A_S$
and source resistances: $R = C \times K$

On the basis of many experimental tank tests, and with the help of pertaining dimensionless hull parameters, some of which have already been discussed, methods have been established for calculating all the necessary

resistance coefficients C and, thus, the pertaining source-resistances R . In practice, the calculation of a particular ship's resistance can be verified by testing a model of the relevant ship in a towing tank.

Frictional resistance R_F

The frictional resistance R_F of the hull depends on the size of the hull's wetted area A_S , and on the specific frictional resistance coefficient C_F . The friction increases with fouling of the hull, i.e. by the growth of, i.a. algae, sea grass and barnacles.

An attempt to avoid fouling is made by the use of anti-fouling hull paints to prevent the hull from becoming "long-haired", i.e. these paints reduce the possibility of the hull becoming fouled by living organisms. The paints containing TBT (tributyl tin) as their principal biocide, which is very toxic, have dominated the market for decades, but the IMO ban of TBT for new applications from 1 January, 2003, and a full ban from 1 January, 2008, may involve the use of new (and maybe not as effective) alternatives, probably copper-based anti-fouling paints.

When the ship is propelled through the water, the frictional resistance increases at a rate that is virtually equal to the square of the vessel's speed.

Frictional resistance represents a considerable part of the ship's resistance, often some 70-90% of the ship's total resistance for low-speed ships (bulk carriers and tankers), and sometimes less than 40% for high-speed ships (cruise liners and passenger ships) [1]. The frictional resistance is found as follows:

$$R_F = C_F \times K$$

Residual resistance R_R

Residual resistance R_R comprises wave resistance and eddy resistance. Wave resistance refers to the energy loss caused by waves created by the vessel during its propulsion through the water, while eddy resistance refers to the loss caused by flow separation which creates eddies, particularly at the aft end of the ship.

Wave resistance at low speeds is proportional to the square of the speed, but increases much faster at higher speeds. In principle, this means that a speed barrier is imposed, so that a further increase of the ship's propulsion power will not result in a higher speed as all the power will be converted into wave energy. The residual resistance normally represents 8-25% of the total resistance for low-speed ships, and up to 40-60% for high-speed ships [1].

Incidentally, shallow waters can also have great influence on the residual resistance, as the displaced water under the ship will have greater difficulty in moving aftwards.

The procedure for calculating the specific residual resistance coefficient C_R is described in specialised literature [2] and the residual resistance is found as follows:

$$R_R = C_R \times K$$

Air resistance R_A

In calm weather, air resistance is, in principle, proportional to the square of the ship's speed, and proportional to the cross-sectional area of the ship above the waterline. Air resistance normally represents about 2% of the total resistance.

For container ships in head wind, the air resistance can be as much as 10%. The air resistance can, similar to the foregoing resistances, be expressed as $R_A = C_A \times K$, but is sometimes based on 90% of the dynamic pressure of air with a speed of V , i.e.:

$$R_A = 0.90 \times \frac{1}{2} \times \rho_{air} \times V^2 \times A_{air}$$

where ρ_{air} is the density of the air, and A_{air} is the cross-sectional area of the vessel above the water [1].

Towing resistance R_T

and effective (towing) power P_E
The ship's total towing resistance R_T is thus found as:

$$R_T = R_F + R_R + R_A$$

The corresponding effective (towing) power, P_E , necessary to move the ship

through the water, i.e. to tow the ship at the speed V , is then:

$$P_E = V \times R_T$$

The power delivered to the propeller, P_D , in order to move the ship at speed V is, however, somewhat larger. This is due, in particular, to the flow conditions around the propeller and the propeller efficiency itself, the influences of which are discussed in the next chapter which deals with Propeller Propulsion.

Total ship resistance in general

When dividing the residual resistance into wave and eddy resistance, as earlier described, the distribution of the total ship towing resistance R_T could also, as a guideline, be stated as shown in Fig. 4.

The right column is valid for low-speed ships like bulk carriers and tankers, and the left column is valid for very high-speed ships like cruise liners and ferries. Container ships may be placed in between the two columns.

The main reason for the difference between the two columns is, as earlier mentioned, the wave resistance. Thus, in general all the resistances are proportional to the square of the speed, but for higher speeds the wave resistance increases much faster, involving a higher part of the total resistance.

This tendency is also shown in Fig. 5 for a 600 teu container ship, originally designed for the ship speed of 15 knots. Without any change to the hull design,

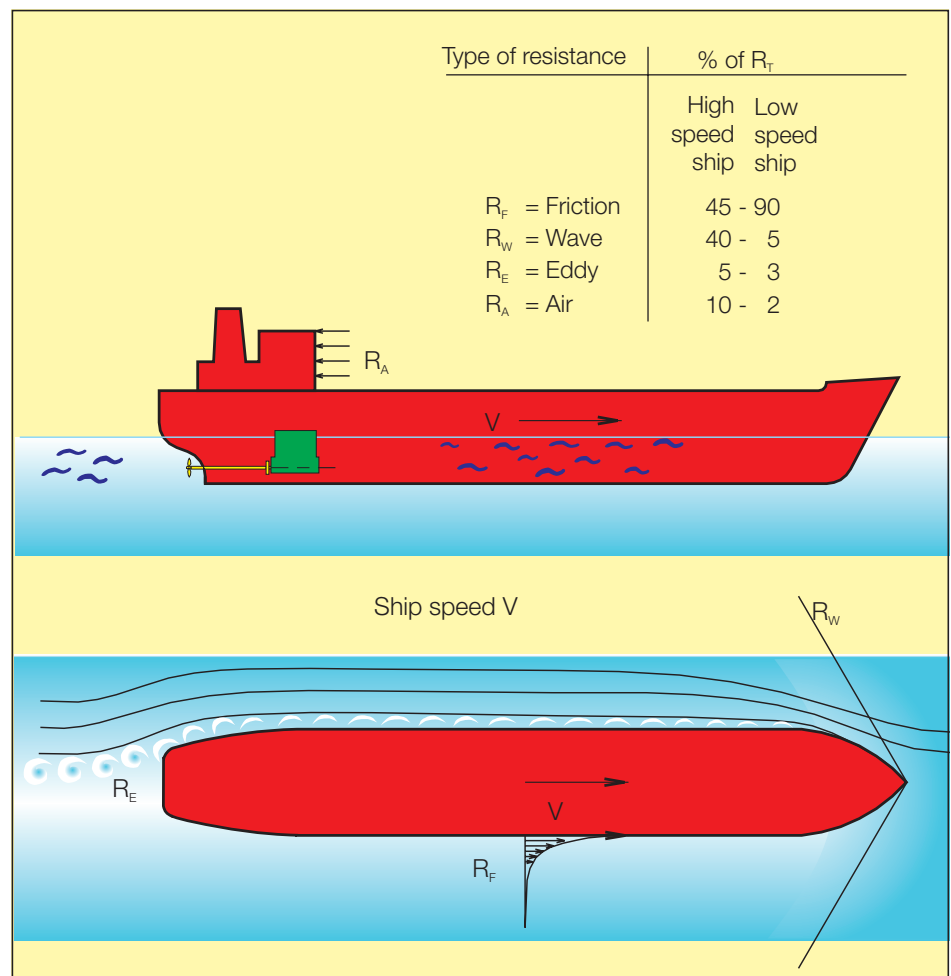

Fig. 4: Total ship towing resistance $R_T = R_F + R_W + R_E + R_A$

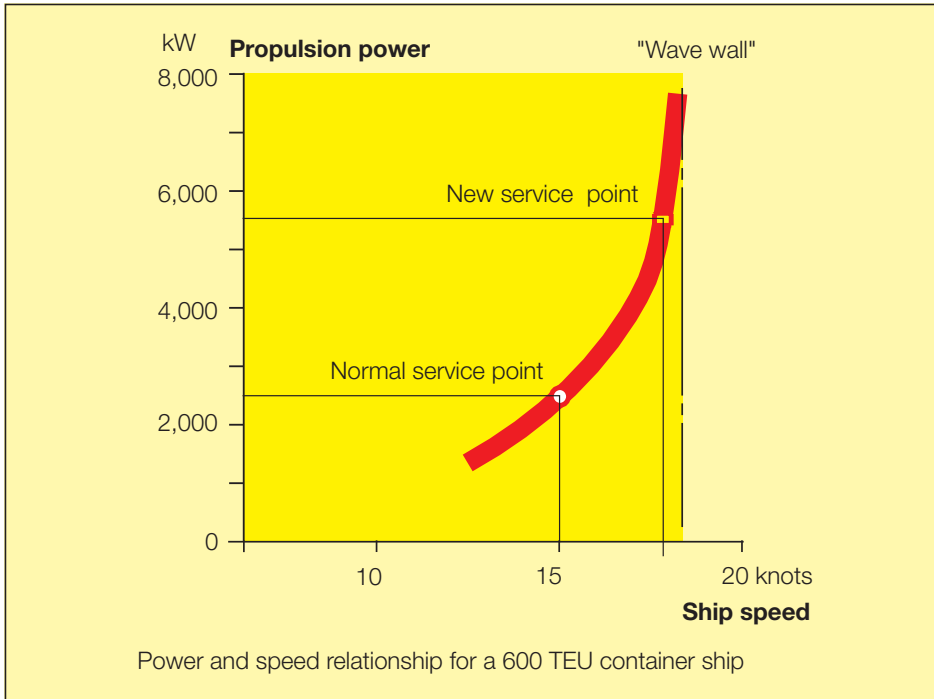

Fig. 5: The “wave wall” ship speed barrier

the ship speed for a sister ship was requested to be increased to about 17.6 knots. However, this would lead to a relatively high wave resistance, requiring a doubling of the necessary propulsion power.

A further increase of the propulsion power may only result in a minor ship speed increase, as most of the extra power will be converted into wave energy, i.e. a ship speed barrier valid for the given hull design is imposed by what we could call a “wave wall”, see Fig. 5. A modification of the hull lines, suiting the higher ship speed, is necessary.

Increase of ship resistance in service, Ref. [3], page 244

During the operation of the ship, the paint film on the hull will break down. Erosion will start, and marine plants and barnacles, etc. will grow on the surface of the hull. Bad weather, perhaps in connection with an inappropriate distribution of the cargo, can be a reason for buckled bottom plates. The hull has been fouled and will no longer have a “technically smooth” surface,

which means that the frictional resistance will be greater. It must also be considered that the propeller surface can become rough and fouled. The total resistance, caused by fouling, may increase by 25-50% throughout the lifetime of a ship.

Experience [4] shows that hull fouling with barnacles and tube worms may cause an increase in drag (ship resistance) of up to 40%, with a drastical reduction of the ship speed as the consequence.

Furthermore, in general [4] for every 25 μm (25/1000 mm) increase of the average hull roughness, the result will be a power increase of 2-3%, or a ship speed reduction of about 1%.

Resistance will also increase because of sea, wind and current, as shown in Table 4 for different main routes of ships. The resistance when navigating in head-on sea could, in general, increase by as much as 50-100% of the total ship resistance in calm weather.

Estimates of average increase in resistance for ships navigating the main routes:	
North Atlantic route, navigation westward	25-35%
North Atlantic route, navigation eastward	20-25%
Europe-Australia	20-25%
Europe-East Asia	20-25%
The Pacific routes	20-30%

Table 4: Main routes of ships

On the North Atlantic routes, the first percentage corresponds to summer navigation and the second percentage to winter navigation.

However, analysis of trading conditions for a typical 140,000 dwt bulk carrier shows that on some routes, especially Japan-Canada when loaded, the increased resistance (sea margin) can reach extreme values up to 220%, with an average of about 100%.

Unfortunately, no data have been published on increased resistance as a function of type and size of vessel. The larger the ship, the less the relative increase of resistance due to the sea. On the other hand, the frictional resistance of the large, full-bodied ships will very easily be changed in the course of time because of fouling.

In practice, the increase of resistance caused by heavy weather depends on the current, the wind, as well as the wave size, where the latter factor may have great influence. Thus, if the wave size is relatively high, the ship speed will be somewhat reduced even when sailing in fair seas.

In principle, the increased resistance caused by heavy weather could be related to:

- a) wind and current against, and
- b) heavy waves,

but in practice it will be difficult to distinguish between these factors.

Chapter 2

Propeller Propulsion

The traditional agent employed to move a ship is a propeller, sometimes two and, in very rare cases, more than two. The necessary propeller thrust T required to move the ship at speed V is normally greater than the pertaining towing resistance R_T , and the flow-related reasons are, amongst other reasons, explained in this chapter. See also Fig. 6, where all relevant velocity, force, power and efficiency parameters are shown.

Propeller types

Propellers may be divided into the following two main groups, see also Fig. 7:

- Fixed pitch propeller (FP-propeller)
- Controllable pitch propeller (CP-propeller)

Propellers of the FP-type are cast in one block and normally made of a copper alloy. The position of the blades, and thereby the propeller pitch, is once and for all fixed, with a given pitch that cannot be changed in operation. This means that when operating in, for example, heavy weather conditions, the propeller performance curves, i.e. the combination of power and speed (r/min) points, will change according to the physical laws, and the actual propeller curve cannot be changed by the crew. Most ships which do not need a particularly good manoeuvrability are equipped with an FP-propeller.

Propellers of the CP-type have a relatively larger hub compared with the FP-propellers because the hub has to have space for a hydraulically activated mechanism for control of the pitch (angle) of the blades. The CP-propeller is relatively expensive, maybe up to 3-4 times as expensive as a corresponding FP-propeller. Furthermore, because of the relatively larger hub, the propeller efficiency is slightly lower.

CP-propellers are mostly used for Ro-Ro ships, shuttle tankers and similar ships that require a high degree of

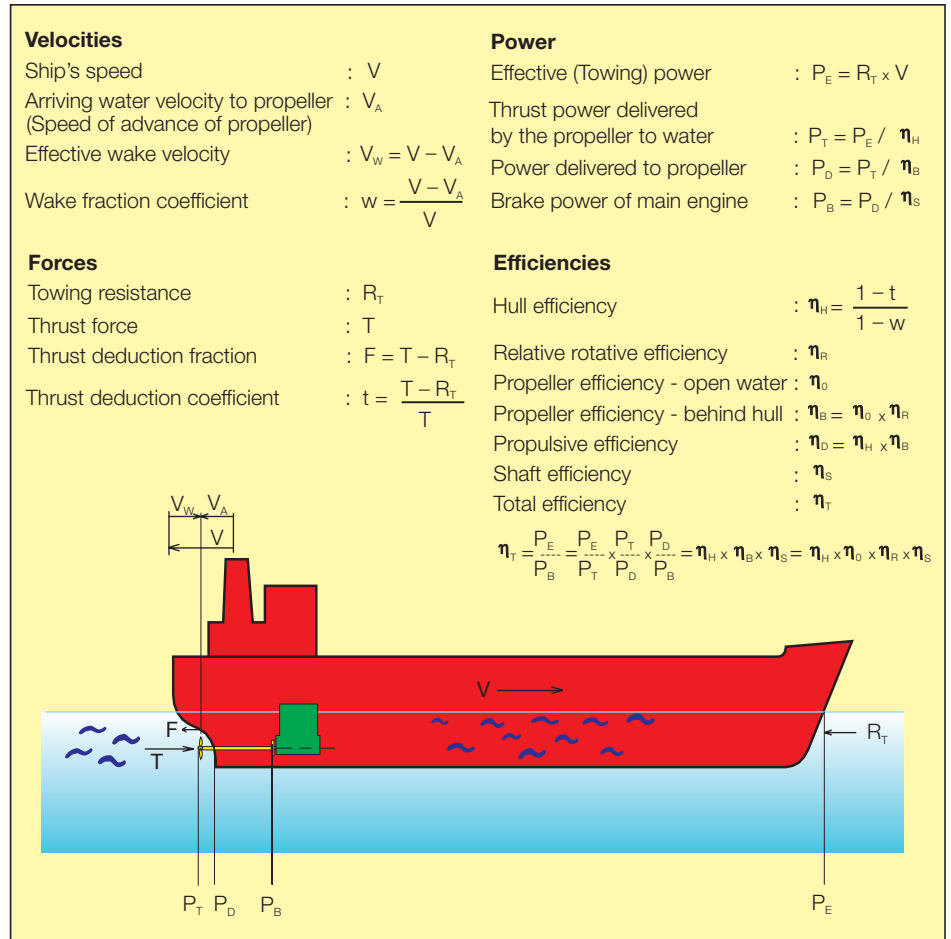

Fig. 6: The propulsion of a ship – theory

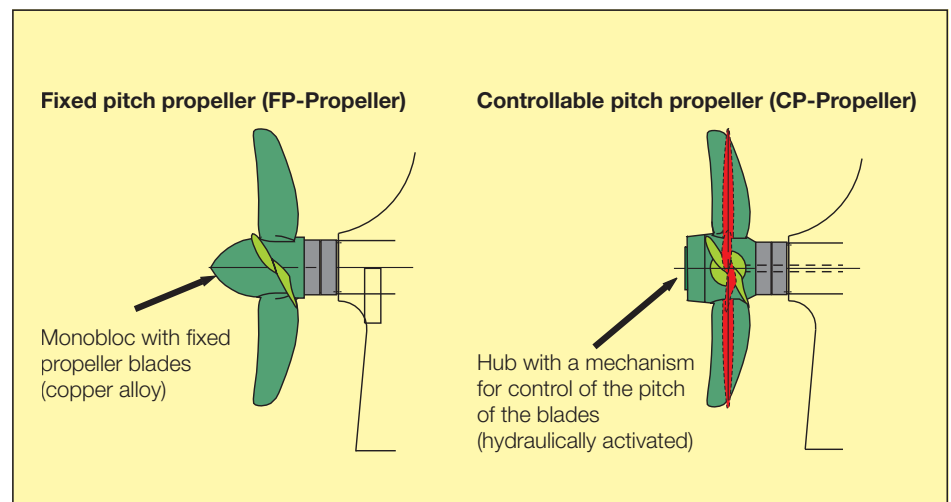

Fig. 7: Propeller types

manoeuvrability. For ordinary ships like container ships, bulk carriers and crude oil tankers sailing for a long time in normal sea service at a given ship speed, it will, in general, be a waste of money to install an expensive CP-propeller instead of an FP-propeller. Furthermore, a CP-propeller is more complicated, involving a higher risk of problems in service.

Flow conditions around the propeller

Wake fraction coefficient w

When the ship is moving, the friction of the hull will create a so-called friction belt or boundary layer of water around the hull. In this friction belt the velocity of the water on the surface of the hull is equal to that of the ship, but is reduced with its distance from the surface of the hull. At a certain distance from the hull and, per definition, equal to the outer "surface" of the friction belt, the water velocity is equal to zero.

The thickness of the friction belt increases with its distance from the fore end of the hull. The friction belt is therefore thickest at the aft end of the hull and this thickness is nearly proportional to the length of the ship, Ref. [5]. This means that there will be a certain wake velocity caused by the friction along the sides of the hull. Additionally, the ship's displacement of water will also cause wake waves both fore and aft. All this involves that the propeller behind the hull will be working in a wake field.

Therefore, and mainly originating from the friction wake, the water at the propeller will have an effective wake velocity V_w which has the same direction as the ship's speed V , see Fig. 6. This means that the velocity of arriving water V_A at the propeller, (equal to the speed of advance of the propeller) given as the average velocity over the propeller's disk area is V_w lower than the ship's speed V .

The effective wake velocity at the propeller is therefore equal to $V_w = V - V_A$ and may be expressed in dimensionless form by means of the wake fraction coefficient w . The normally used wake fraction coefficient w given by Taylor is defined as:

$$w = \frac{V_w}{V} = \frac{V - V_A}{V}$$

(you get $\frac{V_A}{V} = 1 - w$)

The value of the wake fraction coefficient depends largely on the shape of the hull, but also on the propeller's location and size, and has great influence on the propeller's efficiency.

The propeller diameter or, even better, the ratio between the propeller diameter d and the ship's length L_{WL} has some influence on the wake fraction coefficient, as d/L_{WL} gives a rough indication of the degree to which the propeller works in the hull's wake field. Thus, the larger the ratio d/L_{WL} , the lower w will be. The wake fraction coefficient w increases when the hull is fouled.

For ships with one propeller, the wake fraction coefficient w is normally in the region of 0.20 to 0.45, corresponding to a flow velocity to the propeller V_A of 0.80 to 0.55 of the ship's speed V . The larger the block coefficient, the larger is the wake fraction coefficient. On ships with two propellers and a conventional aftbody form of the hull, the propellers will normally be positioned outside the friction belt, for which reason the wake fraction coefficient w will, in this case, be a great deal lower. However, for a twin-skeg ship with two propellers, the coefficient w will be almost unchanged (or maybe slightly lower) compared with the single-propeller case.

Incidentally, a large wake fraction coefficient increases the risk of propeller cavitation, as the distribution of the water velocity around the propeller is generally very inhomogeneous under such conditions.

A more homogeneous wake field for the propeller, also involving a higher speed of advance V_A of the propeller, may sometimes be needed and can be obtained in several ways, e.g. by having the propellers arranged in nozzles, below shields, etc. Obviously, the best method is to ensure, already at the design stage, that the aft end of the hull is shaped in such a way that the optimum wake field is obtained.

Thrust deduction coefficient t

The rotation of the propeller causes the water in front of it to be "sucked" back towards the propeller. This results in an extra resistance on the hull normally called "augment of resistance" or, if related to the total required thrust force T on the propeller, "thrust deduction fraction" F , see Fig. 6. This means that the thrust force T on the propeller has to overcome both the ship's resistance R_T and this "loss of thrust" F .

The thrust deduction fraction F may be expressed in dimensionless form by means of the thrust deduction coefficient t , which is defined as:

$$t = \frac{F}{T} = \frac{T - R_T}{T}$$

(you get $\frac{R_T}{T} = 1 - t$)

The thrust deduction coefficient t can be calculated by using calculation models set up on the basis of research carried out on different models.

In general, the size of the thrust deduction coefficient t increases when the wake fraction coefficient w increases. The shape of the hull may have a significant influence, e.g. a bulbous stem can, under certain circumstances (low ship speeds), reduce t .

The size of the thrust deduction coefficient t for a ship with one propeller is, normally, in the range of 0.12 to 0.30, as a ship with a large block coefficient has a large thrust deduction coefficient. For ships with two propellers and a conventional aftbody form of the hull, the thrust deduction coefficient t will be much less as the propellers' "sucking" occurs further away from the hull. However, for a twin-skeg ship with two propellers, the coefficient t will be almost unchanged (or maybe slightly lower) compared with the single-propeller case.

Efficiencies

Hull efficiency η_H

The hull efficiency η_H is defined as the ratio between the effective (towing) power $P_E = R_T \times V$, and the thrust power

which the propeller delivers to the water $P_T = T \times V_A$, i.e.:

$$\eta_H = \frac{P_E}{P_T} = \frac{R_T \times V}{T \times V_A} = \frac{R_T / T}{V_A / V} = \frac{1-t}{1-w}$$

For a ship with one propeller, the hull efficiency η_H is usually in the range of 1.1 to 1.4, with the high value for ships with high block coefficients. For ships with two propellers and a conventional aftbody form of the hull, the hull efficiency η_H is approx. 0.95 to 1.05, again with the high value for a high block coefficient. However, for a twin-skeg ship with two propellers, the hull coefficient η_H will be almost unchanged compared with the single-propeller case.

Open water propeller efficiency η_O

Propeller efficiency η_O is related to working in open water, i.e. the propeller works in a homogeneous wake field with no hull in front of it.

The propeller efficiency depends, especially, on the speed of advance V_A , thrust force T , rate of revolution n , diameter d and, moreover, i.a. on the design of the propeller, i.e. the number of blades, disk area ratio, and pitch/diameter ratio – which will be discussed later in this chapter. The propeller efficiency η_O can vary between approx. 0.35 and 0.75, with the high value being valid for propellers with a high speed of advance V_A , Ref. [3].

Fig. 8 shows the obtainable propeller efficiency η_O shown as a function of the speed of advance V_A , which is given in dimensionless form as:

$$J = \frac{V_A}{n \times d}$$

where J is the advance number of the propeller.

Relative rotative efficiency η_R

The actual velocity of the water flowing to the propeller behind the hull is neither constant nor at right angles to the propeller's disk area, but has a kind of rotational flow. Therefore, compared with when the propeller is working in open water, the propeller's efficiency is

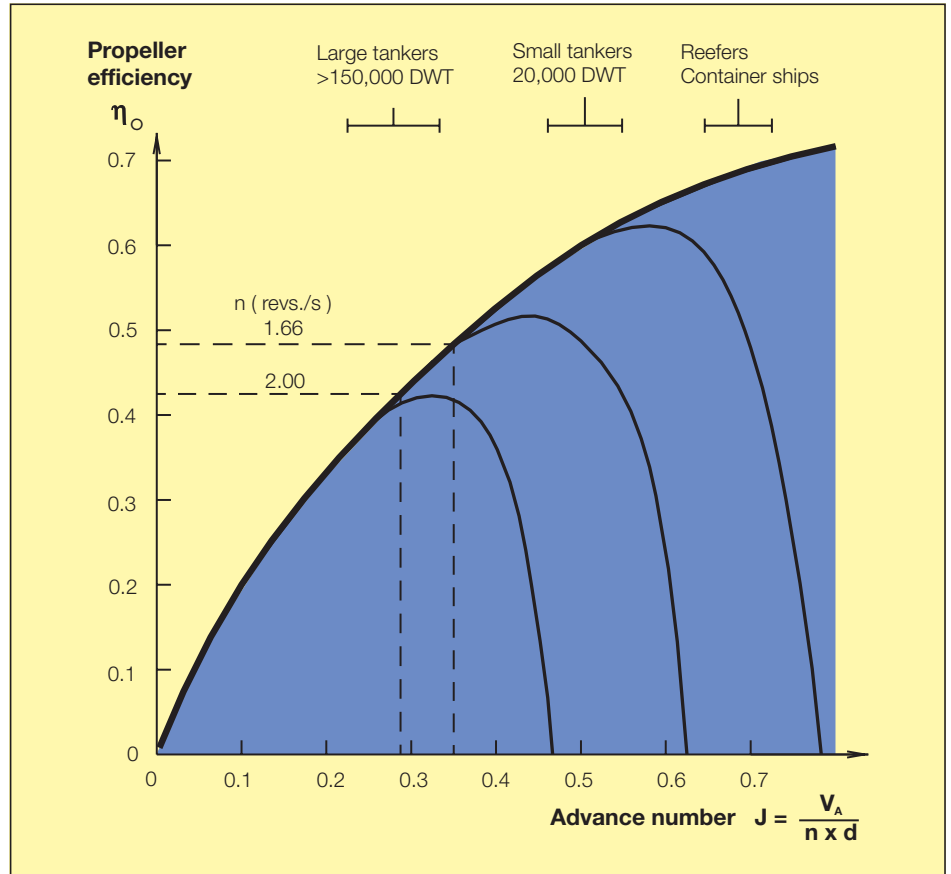

Fig. 8: Obtainable propeller efficiency – open water, Ref. [3], page 213

affected by the η_R factor – called the propeller's relative rotative efficiency.

On ships with a single propeller the rotative efficiency η_R is, normally, around 1.0 to 1.07, in other words, the rotation of the water has a beneficial effect. The rotative efficiency η_R on a ship with a conventional hull shape and with two propellers will normally be less, approx. 0.98, whereas for a twin-skeg ship with two propellers, the rotative efficiency η_R will be almost unchanged.

In combination with w and t , η_R is probably often being used to adjust the results of model tank tests to the theory.

Propeller efficiency η_B working behind the ship

The ratio between the thrust power P_T , which the propeller delivers to the wa-

ter, and the power P_D , which is delivered to the propeller, i.e. the propeller efficiency η_B for a propeller working behind the ship, is defined as:

$$\eta_B = \frac{P_T}{P_D} = \eta_O \times \eta_R$$

Propulsive efficiency η_D

The propulsive efficiency η_D , which must not be confused with the open water propeller efficiency η_O , is equal to the ratio between the effective (towing) power P_E and the necessary power delivered to the propeller P_D , i.e.:

$$\eta_D = \frac{P_E}{P_D} = \frac{P_E}{P_T} \times \frac{P_T}{P_D} = \eta_H \times \eta_B = \eta_H \times \eta_O \times \eta_R$$

As can be seen, the propulsive efficiency η_D is equal to the product of the hull efficiency η_H , the open water propeller efficiency η_O , and the relative rotative efficiency η_R , although the latter has less significance.

In this connection, one can be led to believe that a hull form giving a high wake fraction coefficient w , and hence a high hull efficiency η_H , will also provide the best propulsive efficiency η_D .

However, as the open water propeller efficiency η_O is also greatly dependent on the speed of advance V_A , cf. Fig. 8, that is decreasing with increased w , the propulsive efficiency η_D will not, generally, improve with increasing w , quite often the opposite effect is obtained.

Generally, the best propulsive efficiency is achieved when the propeller works in a homogeneous wake field.

Shaft efficiency η_S

The shaft efficiency η_S depends, i.a. on the alignment and lubrication of the shaft bearings, and on the reduction gear, if installed.

Shaft efficiency is equal to the ratio between the power P_D delivered to the propeller and the brake power P_B delivered by the main engine, i.e.

$$\eta_S = \frac{P_D}{P_B}$$

The shaft efficiency is normally around 0.985, but can vary between 0.96 and 0.995.

Total efficiency η_T

The total efficiency η_T , which is equal to the ratio between the effective (towing) power P_E and the necessary brake power P_B delivered by the main engine, can be expressed thus:

$$\eta_T = \frac{P_E}{P_B} = \frac{P_E}{P_D} \times \frac{P_D}{P_B}$$

$$= \eta_D \times \eta_S = \eta_H \times \eta_O \times \eta_R \times \eta_S$$

Propeller dimensions

Propeller diameter d

With a view to obtaining the highest possible propulsive efficiency η_D , the largest possible propeller diameter d will, normally, be preferred. There are, however, special conditions to be considered. For one thing, the aftbody form of the hull can vary greatly depending on type of ship and ship design, for another, the necessary clearance between the tip of the propeller and the hull will depend on the type of propeller.

For bulkers and tankers, which are often sailing in ballast condition, there are frequent demands that the propeller shall be fully immersed also in this condition, giving some limitation to the propeller size. This propeller size limitation is not particularly valid for container ships as they rarely sail in ballast condition. All the above factors mean that an exact propeller diameter/design draught ratio d/D cannot be given here but, as a rule-of-thumb, the below mentioned approximations of the diameter/design draught ratio d/D can be presented, and a large diameter d will, normally, result in a low rate of revolution n .

Bulk carrier and tanker:

$$d/D < \text{approximately } 0.65$$

Container ship:

$$d/D < \text{approximately } 0.74$$

For strength and production reasons, the propeller diameter will generally not exceed 10.0 metres and a power output of about 90,000 kW. The largest-diameter propeller manufactured so far is of 11.0 metres and has four propeller blades.

Number of propeller blades

Propellers can be manufactured with 2, 3, 4, 5 or 6 blades. The fewer the number of blades, the higher the propeller efficiency will be. However, for reasons of strength, propellers which are to be subjected to heavy loads cannot be manufactured with only two or three blades.

Two-bladed propellers are used on small ships, and 4, 5 and 6-bladed propellers are used on large ships. Ships using the MAN B&W two-stroke engines are normally large-type vessels which use 4-bladed propellers. Ships with a relatively large power requirement and heavily loaded propellers, e.g. container ships, may need 5 or 6-bladed propellers. For vibrational reasons, propellers with certain numbers of blades may be avoided in individual cases in order not to give rise to the excitation of natural frequencies in the ship's hull or superstructure, Ref. [5].

Disk area coefficient

The disk area coefficient – referred to in older literature as expanded blade area ratio – defines the developed surface area of the propeller in relation to its disk area. A factor of 0.55 is considered as being good. The disk area coefficient of traditional 4-bladed propellers is of little significance, as a higher value will only lead to extra resistance on the propeller itself and, thus, have little effect on the final result.

For ships with particularly heavy-loaded propellers, often 5 and 6-bladed propellers, the coefficient may have a higher value. On warships it can be as high as 1.2.

Pitch diameter ratio p/d

The pitch diameter ratio p/d , expresses the ratio between the propeller's pitch p and its diameter d , see Fig. 10. The pitch p is the distance the propeller "screws" itself forward through the water per revolution, providing that there is no slip – see also the next section and Fig. 10. As the pitch can vary along the blade's radius, the ratio is normally related to the pitch at $0.7 \times r$, where $r = d/2$ is the propeller's radius.

To achieve the best propulsive efficiency for a given propeller diameter, an optimum pitch/diameter ratio is to be found, which again corresponds to a particular design rate of revolution. If, for instance, a lower design rate of revolution is desired, the pitch/diameter ratio has to be increased, and vice versa, at the cost of efficiency. On the other hand, if a lower design rate of revolution is desired, and the ship's draught permits, the choice of a larger propeller diame-

ter may permit such a lower design rate of revolution and even, at the same time, increase the propulsive efficiency.

Propeller coefficients J , K_T and K_Q
Propeller theory is based on models, but to facilitate the general use of this theory, certain dimensionless propeller coefficients have been introduced in relation to the diameter d , the rate of revolution n , and the water's mass density ρ . The three most important of these coefficients are mentioned below.

The advance number of the propeller J is, as earlier mentioned, a dimensionless expression of the propeller's speed of advance V_A .

$$J = \frac{V_A}{n \times d}$$

The thrust force T , is expressed dimensionless, with the help of the thrust coefficient K_T , as

$$K_T = \frac{T}{\rho \times n^2 \times d^4}$$

and the propeller torque

$$Q = \frac{P_D}{2\pi \times n}$$

is expressed dimensionless with the help of the torque coefficient K_Q , as

$$K_Q = \frac{Q}{\rho \times n^2 \times d^5}$$

The propeller efficiency η_o can be calculated with the help of the above-mentioned coefficients, because, as previously mentioned, the propeller efficiency η_o is defined as:

$$\eta_o = \frac{P_T}{P_D} = \frac{T \times V_A}{Q \times 2\pi \times n} = \frac{K_T}{K_Q} \times \frac{J}{2\pi}$$

With the help of special and very complicated propeller diagrams, which contain, i.a. J , K_T and K_Q curves, it is possible to find/calculate the propeller's dimensions, efficiency, thrust, power, etc.

ISO 484/1 – 1981 (CE)		
Class	Manufacturing accuracy	Mean pitch for propeller
S	Very high accuracy	+/- 0.5 %
I	High accuracy	+/- 0.75 %
II	Medium accuracy	+/- 1.00 %
III	Wide tolerances	+/- 3.00 %

Table 5: Manufacturing accuracy classes of a propeller

Manufacturing accuracy of the propeller

Before the manufacturing of the propeller, the desired accuracy class standard of the propeller must be chosen by the customer. Such a standard is, for example, ISO 484/1 – 1981 (CE), which has four different "Accuracy classes", see Table 5.

Each of the classes, among other details, specifies the maximum allowable tolerance on the mean design pitch of the manufactured propeller, and thereby the tolerance on the corresponding propeller speed (rate of revolution).

The price of the propeller, of course, depends on the selected accuracy class, with the lowest price for class III. However, it is not recommended to use class III, as this class has a too high tolerance. This again means that the mean pitch tolerance should normally be less than +/- 1.0 %.

The manufacturing accuracy tolerance corresponds to a propeller speed tolerance of max. +/- 1.0 %. When also incorporating the influence of the tolerance on the wake field of the hull, the total propeller tolerance on the rate of revolution can be up to +/- 2.0 %. This tolerance has also to be borne in mind when considering the operating conditions of the propeller in heavy weather.

Influence of propeller diameter and pitch/diameter ratio on propulsive efficiency η_D .

As already mentioned, the highest possible propulsive efficiency required to provide a given ship speed is obtained with the largest possible propeller diameter d , in combination with the corresponding, optimum pitch/diameter ratio p/d .

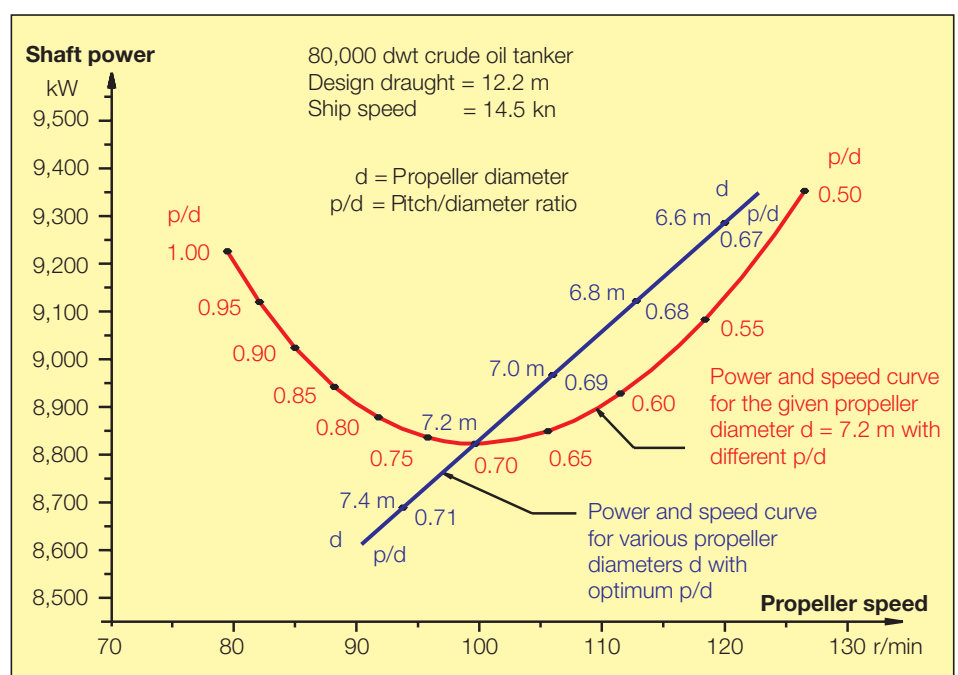

Fig. 9: Propeller design – influence of diameter and pitch

As an example for an 80,000 dwt crude oil tanker, with a service ship speed of 14.5 knots and a maximum possible propeller diameter of 7.2 m, this influence is shown in Fig. 9.

According to the blue curve, the maximum possible propeller diameter of 7.2 m may have the optimum pitch/diameter ratio of 0.70, and the lowest possible shaft power of 8,820 kW at 100 r/min. If the pitch for this diameter is changed, the propulsive efficiency will be reduced, i.e. the necessary shaft power will increase, see the red curve.

The blue curve shows that if a bigger propeller diameter of 7.4 m is possible, the necessary shaft power will be reduced to 8,690 kW at 94 r/min, i.e. the bigger the propeller, the lower the optimum propeller speed.

The red curve also shows that propulsion-wise it will always be an advantage to choose the largest possible propeller diameter, even though the optimum pitch/diameter ratio would involve a too low propeller speed (in relation to the required main engine speed). Thus, when using a somewhat lower pitch/diameter ratio, compared with the optimum ratio, the propeller/ engine speed may be increased and will only cause a minor extra power increase.

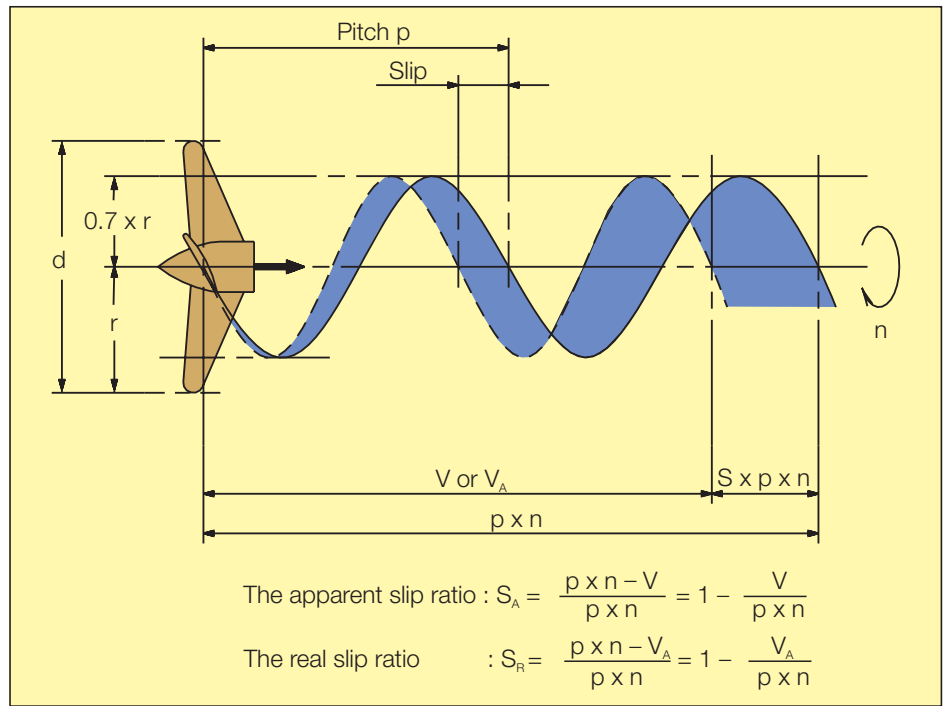

Fig. 10: Movement of a ship's propeller, with pitch p and slip ratio S

The apparent slip ratio S_A , which is dimensionless, is defined as:

$$S_A = \frac{p \times n - V}{p \times n} = 1 - \frac{V}{p \times n}$$

The apparent slip ratio S_A , which is calculated by the crew, provides useful knowledge as it gives an impression of the loads applied to the propeller under different operating conditions. The apparent slip ratio increases when the

Operating conditions of a propeller

Slip ratio S

If the propeller had no slip, i.e. if the water which the propeller "screws" itself through did not yield (i.e. if the water did not accelerate aft), the propeller would move forward at a speed of $V = p \times n$, where n is the propeller's rate of revolution, see Fig. 10.

The similar situation is shown in Fig. 11 for a corkscrew, and because the cork is a solid material, the slip is zero and, therefore, the corkscrew always moves forward at a speed of $V = p \times n$. However, as the water is a fluid and does yield (i.e. accelerate aft), the propeller's apparent speed forward decreases with its slip and becomes equal to the ship's speed V , and its apparent slip can thus be expressed as $p \times n - V$.

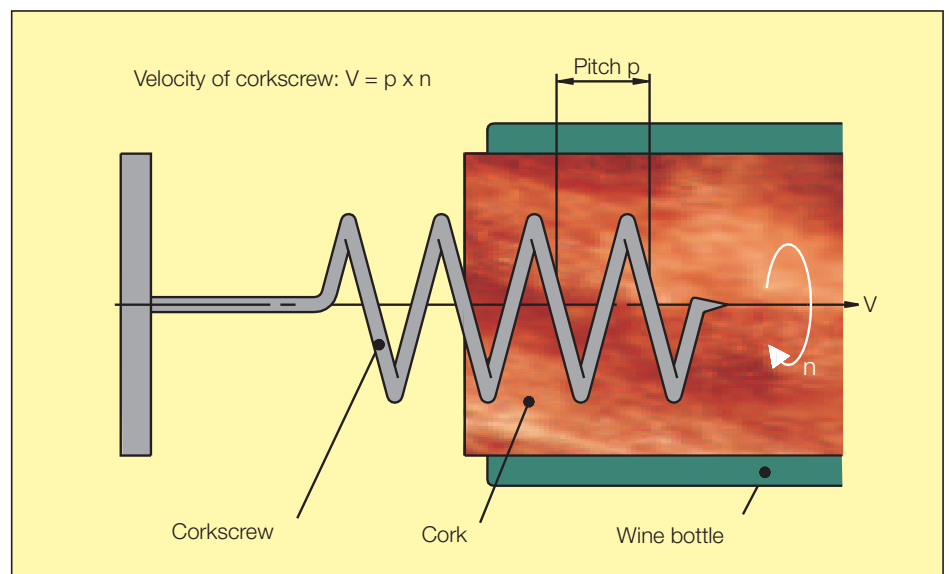

Fig. 11: Movement of a corkscrew, without slip

vessel sails against the wind or waves, in shallow waters, when the hull is fouled, and when the ship accelerates. Under increased resistance, this involves that the propeller speed (rate of revolution) has to be increased in order to maintain the required ship speed.

The real slip ratio will be greater than the apparent slip ratio because the real speed of advance V_A of the propeller is, as previously mentioned, less than the ship's speed V .

The real slip ratio S_R , which gives a truer picture of the propeller's function, is:

$$S_R = 1 - \frac{V_A}{V} = 1 - \frac{V \times (1 - w)}{V} = w$$

At quay trials where the ship's speed is $V = 0$, both slip ratios are 1.0. Incidentally, slip ratios are often given in percentages.

Propeller law in general

As discussed in Chapter 1, the resistance R for lower ship speeds is proportional to the square of the ship's speed V , i.e.:

$$R = c \times V^2$$

where c is a constant. The necessary power requirement P is thus proportional to the speed V to the power of three, thus:

$$P = R \times V = c \times V^3$$

For a ship equipped with a fixed pitch propeller, i.e. a propeller with unchangeable pitch, the ship speed V will be proportional to the rate of revolution n , thus:

$$P = c \times n^3$$

which precisely expresses the propeller law, which states that "the necessary power delivered to the propeller is proportional to the rate of revolution to the power of three".

Actual measurements show that the power and engine speed relationship for a given weather condition is fairly reasonable, whereas the power and ship speed relationship is often seen with a higher power than three. A rea-

sonable relationship to be used for estimations in the normal ship speed range could be as follows:

- For large high-speed ships like container vessels: $P = c \times V^{4.5}$
- For medium-sized, medium-speed ships like feeder container ships, reefers, RoRo ships, etc.: $P = c \times V^{4.0}$
- For low-speed ships like tankers and bulk carriers, and small feeder container ships, etc.: $P = c \times V^{3.5}$

Propeller law for heavy running propeller

The propeller law, of course, can only be applied to identical ship running conditions. When, for example, the ship's hull after some time in service has become fouled and thus become more rough, the wake field will be different from that of the smooth ship (clean hull) valid at trial trip conditions.

A ship with a fouled hull will, consequently, be subject to extra resistance which will give rise to a "heavy propeller condition", i.e. at the same propeller power, the rate of revolution will be lower.

The propeller law now applies to another and "heavier" propeller curve than that applying to the clean hull, propeller curve, Ref. [3], page 243.

The same relative considerations apply when the ship is sailing in a heavy sea against the current, a strong wind, and heavy waves, where also the heavy waves in tail wind may give rise to a heavier propeller running than when running in calm weather. On the other hand, if the ship is sailing in ballast condition, i.e. with a lower displacement, the propeller law now applies to a "lighter" propeller curve, i.e. at the same propeller power, the propeller rate of revolution will be higher.

As mentioned previously, for ships with a fixed pitch propeller, the propeller law is extensively used at part load running. It is therefore also used in MAN B&W Diesel's engine layout and load diagrams to specify the engine's operational curves for light running conditions (i.e. clean hull and calm weather) and heavy running conditions (i.e. for fouled hull

and heavy weather). These diagrams using logarithmic scales and straight lines are described in detail in Chapter 3.

Propeller performance in general at increased ship resistance

The difference between the above-mentioned light and heavy running propeller curves may be explained by an example, see Fig. 12, for a ship using, as reference, 15 knots and 100% propulsion power when running with a clean hull in calm weather conditions. With 15% more power, the corresponding ship speed may increase from 15.0 to 15.6 knots.

As described in Chapter 3, and compared with the calm weather conditions, it is normal to incorporate an extra power margin, the so-called sea margin, which is often chosen to be 15%. This power margin corresponds to extra resistance on the ship caused by the weather conditions. However, for very rough weather conditions the influence may be much greater, as described in Chapter 1.

In Fig. 12a, the propulsion power is shown as a function of the ship speed. When the resistance increases to a level which requires 15% extra power to maintain a ship speed of 15 knots, the operating point A will move towards point B .

In Fig. 12b the propulsion power is now shown as a function of the propeller speed. As a first guess it will often be assumed that point A will move towards B' because an unchanged propeller speed implies that, with unchanged pitch, the propeller will move through the water at an unchanged speed.

If the propeller was a corkscrew moving through cork, this assumption would be correct. However, water is not solid as cork but will yield, and the propeller will have a slip that will increase with increased thrust caused by increased hull resistance. Therefore, point A will move towards B which, in fact, is very close to the propeller curve through A . Point B will now be positioned on a propeller curve which is slightly heavy running compared with the clean hull and calm weather propeller curve.

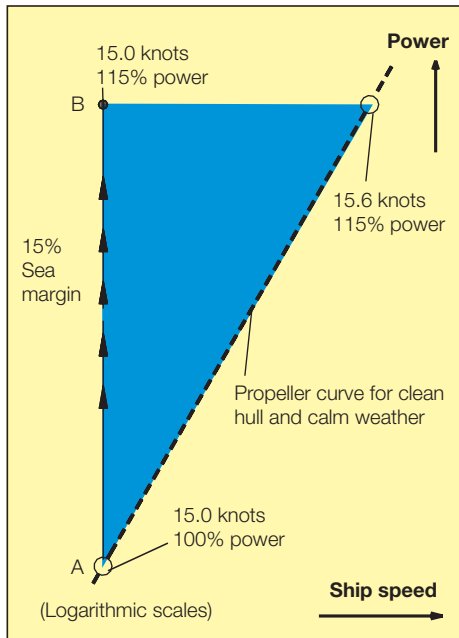

Fig. 12a: Ship speed performance at 15% sea margin

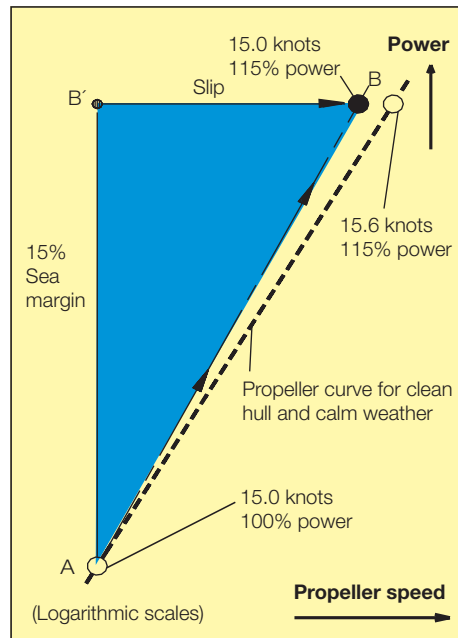

Fig. 12b: Propeller speed performance at 15% sea margin

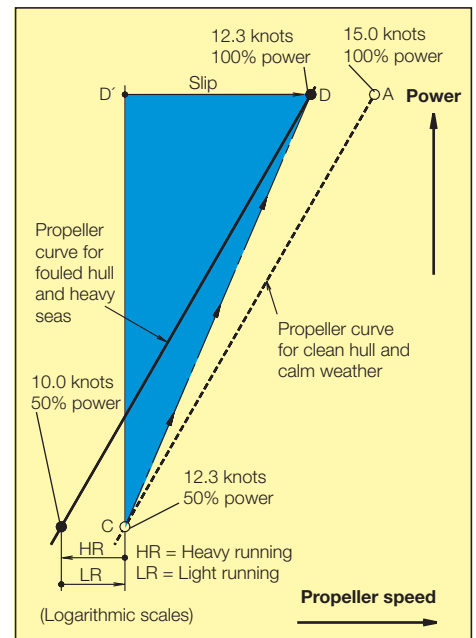

Fig. 12c: Propeller speed performance at large extra ship resistance

Sometimes, for instance when the hull is fouled and the ship is sailing in heavy seas in a head wind, the increase in resistance may be much greater, corresponding to an extra power demand of the magnitude of 100% or even higher. An example is shown in Fig. 12c.

a ducted propeller, the opposite effect is obtained.

Heavy waves and sea and wind against
When sailing in heavy sea against, with heavy wave resistance, the propeller

can be up to 7-8% heavier running than in calm weather, i.e. at the same propeller power, the rate of revolution may be 7-8% lower. An example valid for a smaller container ship is shown in Fig. 13. The service data is measured

In this example, where 100% power will give a ship speed of 15.0 knots, point A, a ship speed of, for instance, 12.3 knots at clean hull and in calm weather conditions, point C, will require about 50% propulsion power but, at the above-mentioned heavy running conditions, it might only be possible to obtain the 12.3 knots by 100% propulsion power, i.e. for 100% power going from point A to D. Running point D may now be placed relatively far to the left of point A, i.e. very heavy running. Such a situation must be considered when laying-out the main engine in relation to the layout of the propeller, as described in Chapter 3.

A scewed propeller (with bent blade tips) is more sensitive to heavy running than a normal propeller, because the propeller is able to absorb a higher torque in heavy running conditions. For

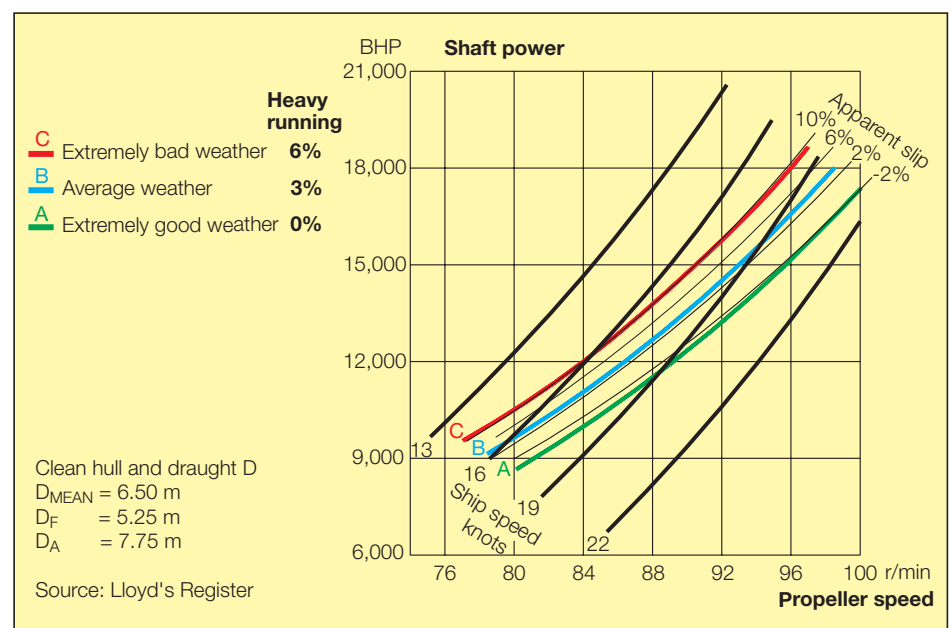

Fig. 13: Service data over a period of a year returned from a single screw container ship

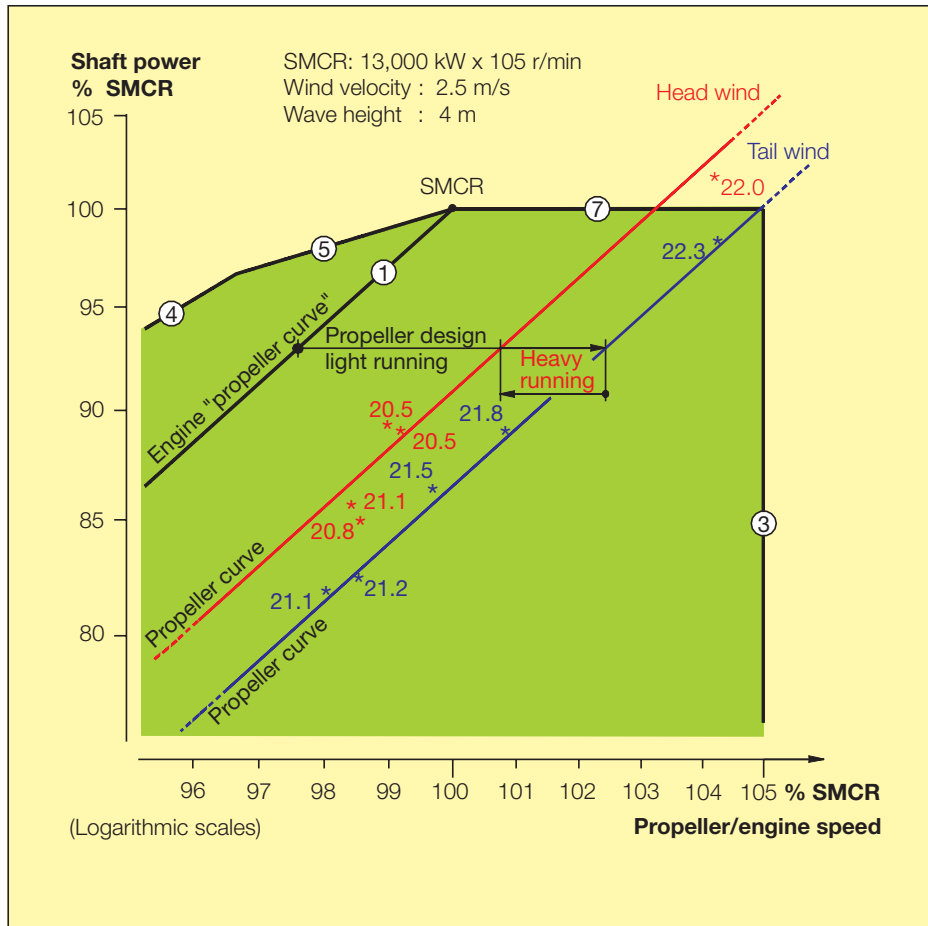

Fig. 14: Measured relationship between power, propeller and ship speed during sea trial of a reefer ship

over a period of one year and only includes the influence of weather conditions! The measuring points have been reduced to three average weather conditions and show, for extremely bad weather conditions, an average heavy running of 6%, and therefore, in practice, the heavy running has proved to be even greater.

In order to avoid slamming of the ship, and thereby damage to the stem and racing of the propeller, the ship speed will normally be reduced by the navigating officer on watch.

Another measured example is shown in Fig. 14, and is valid for a reefer ship during its sea trial. Even though the wind velocity is relatively low, only 2.5 m/s, and the wave height is 4 m, the

measurements indicate approx. 1.5% heavy running when sailing in head wind out, compared with when sailing in tail wind on return.

Ship acceleration

When the ship accelerates, the propeller will be subjected to an even larger load than during free sailing. The power required for the propeller, therefore, will be relatively higher than for free sailing, and the engine's operating point will be heavy running, as it takes some time before the propeller speed has reached its new and higher level. An example with two different accelerations, for an engine without electronic governor and scavenge air pressure limiter, is shown in Fig. 15. The load diagram and scavenge air pressure limiter are described in Chapter 3.

Shallow waters

When sailing in shallow waters, the residual resistance of the ship may be increased and, in the same way as when the ship accelerates, the propeller will be subjected to a larger load than during free sailing, and the propeller will be heavy running.

Influence of displacement

When the ship is sailing in the loaded condition, the ship's displacement volume may, for example, be 10% higher or lower than for the displacement valid for the average loaded condition. This, of course, has an influence on the ship's resistance, and the required propeller power, but only a minor influence on the propeller curve.

On the other hand, when the ship is sailing in the ballast condition, the displacement volume, compared to the loaded condition, can be much lower, and the corresponding propeller curve may apply to, for example, a 2% "lighter" propeller curve, i.e. for the same power to the propeller, the rate of revolution will be 2% higher.

Parameters causing heavy running propeller

Together with the previously described operating parameters which cause a heavy running propeller, the parameters summarised below may give an indication of the risk/sensitivity of getting a heavy running propeller when sailing in heavy weather and rough seas:

- 1 *Relatively small ships (<70,000 dwt)* such as reefers and small container ships are sensitive whereas large ships, such as large tankers and container ships, are less sensitive because the waves are relatively small compared to the ship size.
- 2 *Small ships ($L_{pp} \leq 135 \text{ m} \approx 20,000 \text{ dwt}$)* have low directional stability and, therefore, require frequent rudder corrections, which increase the ship resistance (a self-controlled rudder will reduce such resistance).
- 3 *High-speed ships* are more sensitive than low-speed ships because the waves will act on the fast-going ship with a relatively

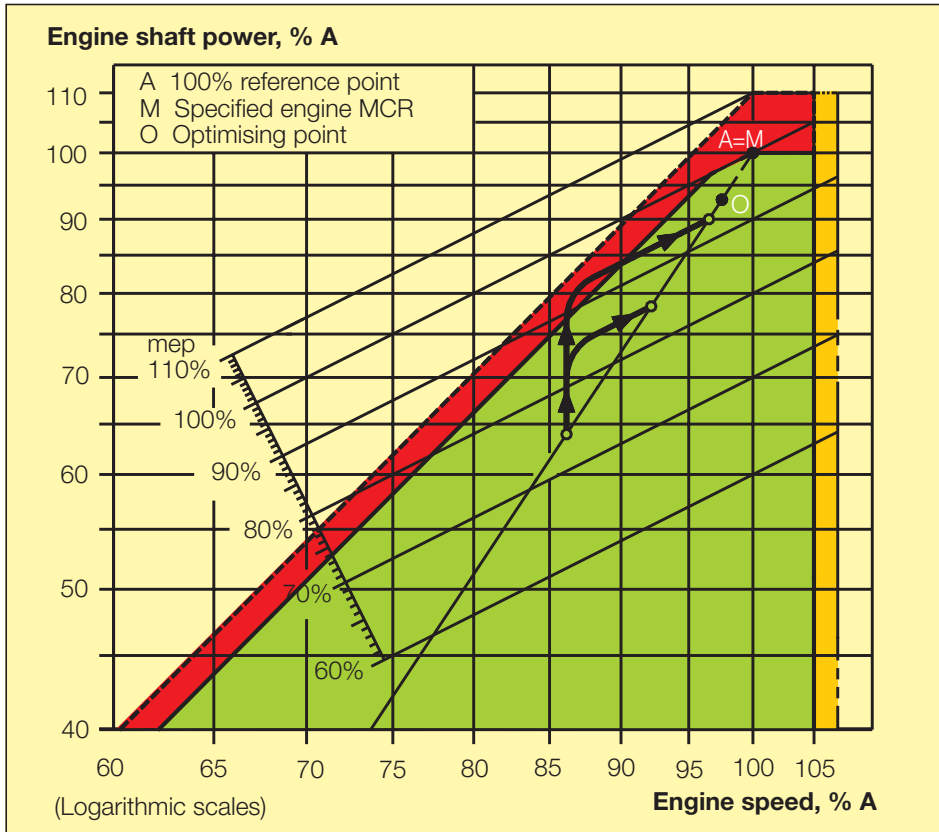

Fig. 15: Load diagram – acceleration

- larger force than on the slow-going ship.
- 4 Ships with a “flat” stern may be slowed down faster by waves than a ship with a “sharp” stern. Thus an axe-shaped upper bow may better cut the waves and thereby reduce the heavy running tendency.
- 5 Fouling of the hull and propeller will increase both hull resistance and propeller torque. Polishing the propeller (especially the tips) as often as possible (also when in water) has a positive effect. The use of effective anti-fouling paints will prevent fouling caused by living organisms.
- 6 Ship acceleration will increase the propeller torque, and thus give a temporarily heavy running propeller.

- 7 Sailing in shallow waters increases the hull resistance and reduces the ship’s directional stability.
- 8 Ships with scewed propeller are able to absorb a higher torque under heavy running conditions.

Manoeuvring speed

Below a certain ship speed, called the manoeuvring speed, the manoeuvrability of the rudder is insufficient because of a too low velocity of the water arriving at the rudder. It is rather difficult to give an exact figure for an adequate manoeuvring speed of the ship as the velocity of the water arriving at the rudder depends on the propeller’s slip stream.

Often a manoeuvring speed of the magnitude of 3.5-4.5 knots is mentioned. According to the propeller law, a correspondingly low propulsion

power will be needed but, of course, this will be higher for running in heavy weather with increased resistance on the ship.

Direction of propeller rotation (side thrust)
When a ship is sailing, the propeller blades bite more in their lowermost position than in their uppermost position. The resulting side-thrust effect is larger the more shallow the water is as, for example, during harbour manoeuvres.

Therefore, a clockwise (looking from aft to fore) rotating propeller will tend to push the ship’s stern in the starboard direction, i.e. pushing the ship’s stern to port, during normal ahead running. This has to be counteracted by the rudder.

When reversing the propeller to astern running as, for example, when berthing alongside the quay, the side-thrust effect is also reversed and becomes further pronounced as the ship’s speed decreases. Awareness of this behaviour is very important in critical situations and during harbour manoeuvres.

According to Ref. [5], page 15-3, the real reason for the appearance of the side thrust during reversing of the propeller is that the upper part of the propeller’s slip stream, which is rotative, strikes the aftbody of the ship.

Thus, also the pilot has to know precisely how the ship reacts in a given situation. It is therefore an unwritten law that on a ship fitted with a fixed pitch propeller, the propeller is always designed for clockwise rotation when sailing ahead. A direct coupled main engine, of course, will have the same rotation.

In order to obtain the same side-thrust effect, when reversing to astern, on ships fitted with a controllable pitch propeller, CP-propellers are designed for anti-clockwise rotation when sailing ahead.

Engine Layout and Load Diagrams

Power functions and logarithmic scales

As is well-known, the effective brake power P_B of a diesel engine is proportional to the mean effective pressure (mep) p_e and engine speed (rate of revolution) n . When using c as a constant, P_B may then be expressed as follows:

$$P_B = c \times p_e \times n$$

or, in other words, for constant mep the power is proportional to the speed:

$$P_B = c \times n^1 \quad (\text{for constant mep})$$

As already mentioned – when running with a fixed pitch propeller – the power may, according to the propeller law, be expressed as:

$$P_B = c \times n^3 \quad (\text{propeller law})$$

Thus, for the above examples, the brake power P_B may be expressed as a function of the speed n to the power of i , i.e.

$$P_B = c \times n^i$$

Fig. 16 shows the relationship between the linear functions, $y = ax + b$, see (A), using linear scales and the power functions $P_B = c \times n^i$, see (B), using logarithmic scales.

The power functions will be linear when using logarithmic scales, as:

$$\log(P_B) = i \times \log(n) + \log(c)$$

which is equivalent to: $y = ax + b$

Thus, propeller curves will be parallel to lines having the inclination $i = 3$, and lines with constant mep will be parallel to lines with the inclination $i = 1$.

Therefore, in the layout and load diagrams for diesel engines, as described in the following, logarithmic scales are used, making simple diagrams with straight lines.

Propulsion and engine running points

Propeller design point PD

Normally, estimations of the necessary propeller power and speed are based on theoretical calculations for loaded ship, and often experimental tank tests, both assuming optimum operating conditions, i.e. a clean hull and good weather. The combination of speed and power obtained may be called the ship's propeller design point PD placed on the light running propeller curve 6,

see Fig. 17. On the other hand, some shipyards and/or propeller manufacturers sometimes use a propeller design point PD' that incorporates all or part of the so-called sea margin described below.

Fouled hull

When the ship has been sailing for some time, the hull and propeller become fouled and the hull's resistance will increase. Consequently, the ship speed will be reduced unless the engine delivers more power to the propeller, i.e. the propeller will be further loaded and will become heavy running HR .

Furthermore, newer high-efficiency ship types have a relatively high ship speed, and a very smooth hull and propeller surface (at sea trial) when the ship is delivered. This means that the inevitable build-up of the surface roughness on the hull and propeller during sea service after sea trial may result in a relatively heavier running propeller, compared with older ships born with a more rough hull surface.

Heavy weather and sea margin used for layout of engine

If, at the same time, the weather is bad, with head winds, the ship's resistance may increase much more, and lead to even heavier running.

When determining the necessary engine power, it is normal practice to add an extra power margin, the so-called sea margin, which is traditionally about 15% of the propeller design PD power. However, for large container ships, 20-30% may sometimes be used.

When determining the necessary engine speed, for layout of the engine, it is recommended – compared with the clean hull and calm weather propeller curve 6 – to choose the heavier propeller curve 2, see Fig. 17, corresponding to curve 6 having a 3-7% higher rate of revolution than curve 2, and in general with 5% as a good choice.

Note that the chosen sea power margin does not equalise the chosen heavy engine propeller curve.

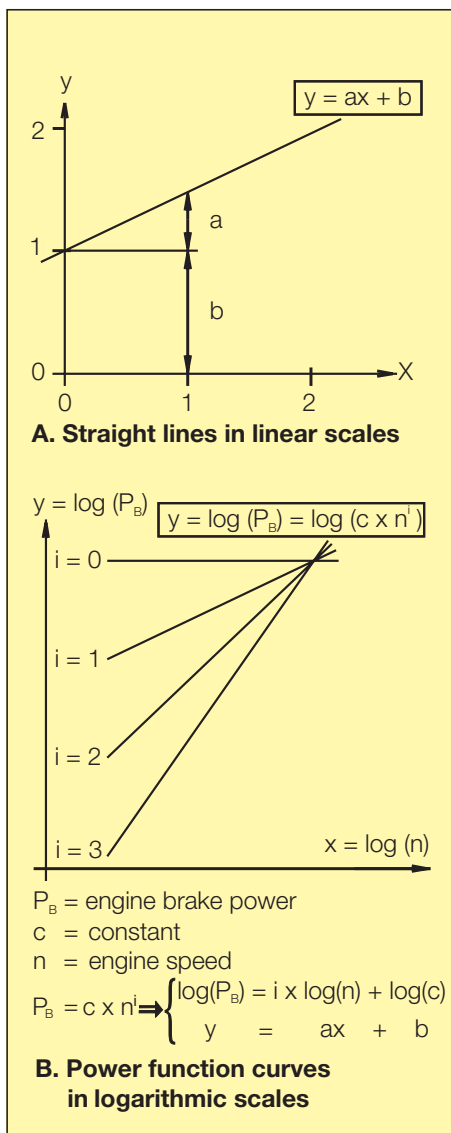

Fig. 16: Relationship between linear functions using linear scales and power functions using logarithmic scales

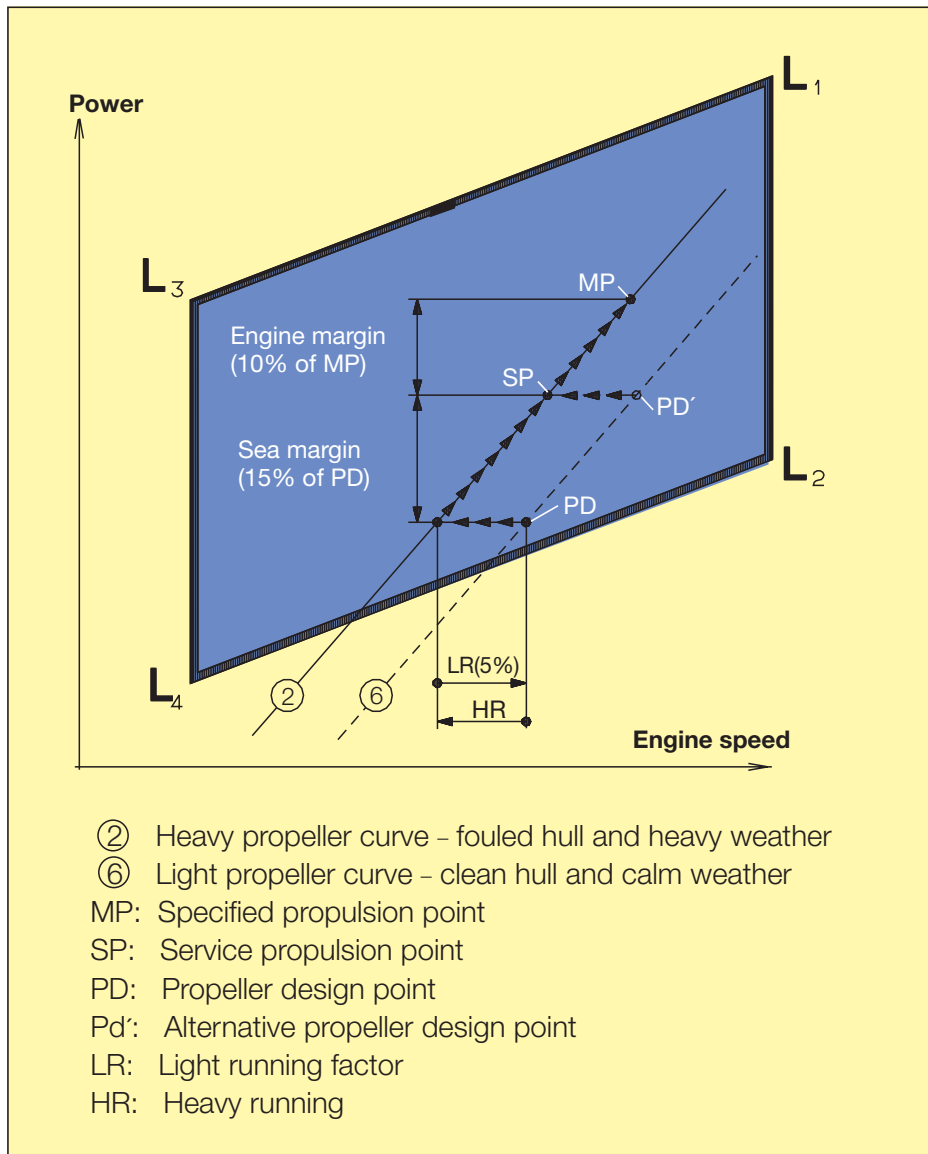

Fig. 17: Ship propulsion running points and engine layout

Continuous service propulsion point SP

The resulting speed and power combination – when including heavy propeller running and sea margin – is called the “continuous service rating for propulsion” SP for fouled hull and heavy weather. The heavy propeller curve, curve 2, for fouled hull and heavy weather will normally be used as the basis for the engine operating curve in service, and the propeller curve for clean hull and calm weather, curve 6, is said to represent a “light running” LR propeller.

Continuous service rating S

The continuous service rating is the power at which the engine, including the sea margin, is assumed to operate, and point S is identical to the service propulsion point SP unless a main engine driven shaft generator is installed.

Light running factor f_{LR}

The heavy propeller curve for a fouled hull and heavy weather, and if no shaft generator is installed may, as mentioned above, be used as the design basis for

the engine operating curve in service, curve 2, whereas the light propeller curve for clean hull and calm weather, curve 6, may be valid for running conditions with new ships, and equal to the layout/design curve of the propeller. Therefore, the light propeller curve for clean hull and calm weather is said to represent a “light running” LR propeller and will be related to the heavy propeller curve for fouled hull and heavy weather condition by means of a light running factor f_{LR} , which, for the same power to the propeller, is defined as the percentage increase of the rate of revolution n , compared to the rate of revolution for heavy running, i.e.

$$f_{LR} = \frac{n_{light} - n_{heavy}}{n_{heavy}} \times 100\%$$

Engine margin

Besides the sea margin, a so-called “engine margin” of some 10-15% is frequently added as an operational margin for the engine. The corresponding point is called the “specified MCR for propulsion” MP, see Fig. 17, and refers to the fact that the power for point SP is 10-15% lower than for point MP, i.e. equal to 90-85% of MP.

Specified MCR M

The engine’s specified MCR point M is the maximum rating required by the yard or owner for continuous operation of the engine. Point M is identical to the specified propulsion MCR point MP unless a main engine driven shaft generator is installed. In such a case, the extra power demand of the shaft generator must also be considered.

Note:

Light/heavy running, fouling and sea margin are overlapping terms. Light/heavy running of the propeller refers to hull and propeller deterioration, and bad weather, and sea margin, i.e. extra power to the propeller, refers to the influence of the wind and the sea.

Based on feedback from service, it seems reasonable to design the propeller for 3-7% light running. The degree of light running must be decided upon, based on experience from the actual trade and hull design, but 5% is often a good choice.

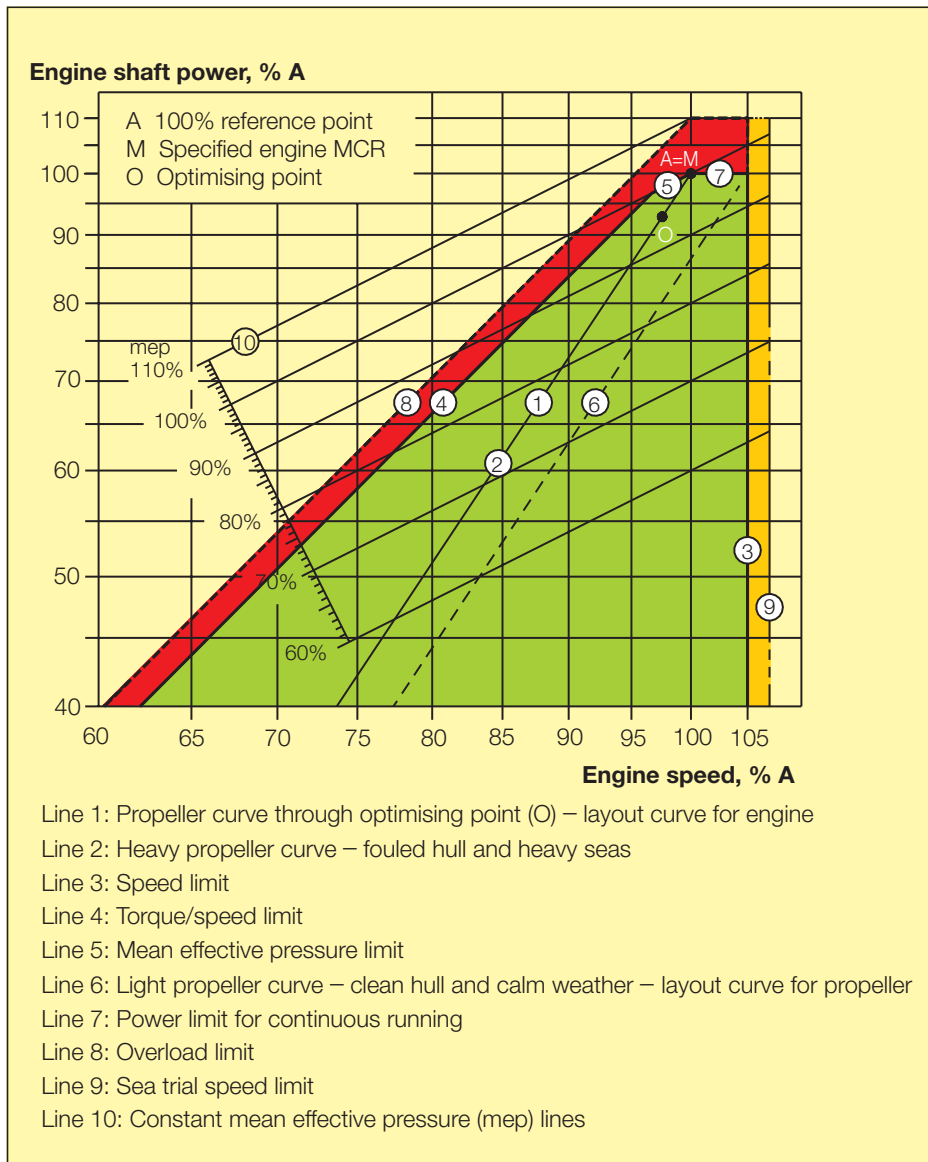

Fig. 18: Engine load diagram

Engine layout diagram

An engine's layout diagram is limited by two constant mean effective pressure (mep) lines L_1 - L_3 and L_2 - L_4 , and by two constant engine speed lines L_1 - L_2 and L_3 - L_4 , see Fig. 17. The L_1 point refers to the engine's nominal maximum continuous rating. Within the layout area there is full freedom to select the engine's specified MCR point M and relevant optimising point O , see below,

which is optimum for the ship and the operating profile. Please note that the lowest specific fuel oil consumption for a given optimising point O will be obtained at 70% and 80% of point O 's power, for electronically (ME) and mechanically (MC) controlled engines, respectively.

Based on the propulsion and engine running points, as previously found, the layout diagram of a relevant main en-

gine may be drawn-in. The specified MCR point M must be inside the limitation lines of the layout diagram; if it is not, the propeller speed will have to be changed or another main engine type must be chosen. Yet, in special cases, point M may be located to the right of line L_1 - L_2 , see "Optimising/Matching Point" below.

Optimising point O

The "Optimising (MC)/Matching (ME) point" O – or, better, the layout point of the engine – is the rating at which the engine (timing and) compression ratio are adjusted, with consideration to the scavenge air pressure of the turbocharger.

As mentioned below, under "Load diagram", the optimising point O (later on in this paper also used in general where matching point for ME engines was the correct one) is placed on line 1 (layout curve of engine) of the load diagram, and the optimised power can be from 85 to 100% of point M 's power. Overload running will still be possible (110% of M 's power), as long as consideration to the scavenge air pressure has been taken.

The optimising point O is to be placed inside the layout diagram. In fact, the specified MCR point M can be placed outside the layout diagram, but only by exceeding line L_1 - L_2 , and, of course, only provided that the optimising point O is located inside the layout diagram.

It should be noted that MC/MC-C engines without VIT (variable injection timing) fuel pumps cannot be optimised at part-load. Therefore, these engines are always optimised in point A , i.e. having point M 's power.

Load diagram

Definitions

The load diagram (Fig. 18) defines the power and speed limits for continuous as well as overload operation of an installed engine which has an optimising point O and a specified MCR point M that conforms to the ship's specification.

Point A is a 100% speed and power reference point of the load diagram, and is defined as the point on the pro-

propeller curve (line 1) – the layout curve of the engine – through the optimising point O, having the specified MCR power.

Normally, point M is equal to point A, but in special cases, for example if a shaft generator is installed, point M may be placed to the right of point A on line 7. The service points of the installed engine incorporate the engine power required for ship propulsion and for the shaft generator, if installed.

During shoptest running, the engine will always operate along curve 1, with point A as 100% MCR. If CP-propeller and constant speed operation is required, the delivery test may be finished with a constant speed test.

Limits to continuous operation

The continuous service range is limited by the four lines 4, 5, 7 and 3 (9), see Fig. 18:

Line 3 and line 9

Line 3 represents the maximum acceptable speed for continuous operation, i.e.

105% of A, however, maximum 105% of L_1 . During sea trial conditions the maximum speed may be extended to 107% of A, see line 9.

The above limits may, in general, be extended to 105% and, during sea trial conditions, to 107% of the nominal L_1 speed of the engine, provided the torsional vibration conditions permit.

The overspeed set-point is 109% of the speed in A, however, it may be moved to 109% of the nominal speed in L_1 , provided that torsional vibration conditions permit.

Running at low load above 100% of the nominal L_1 speed of the engine is, however, to be avoided for extended periods.

Line 4:

Represents the limit at which an ample air supply is available for combustion and imposes a limitation on the maximum combination of torque and speed.

Line 5:

Represents the maximum mean effective pressure level (mep) which can be accepted for continuous operation.

Line 7:

Represents the maximum power for continuous operation.

Line 10:

Represents the mean effective pressure (mep) lines. Line 5 is equal to the 100% mep-line. The mep-lines are also an expression of the corresponding fuel index of the engine.

Limits for overload operation

The overload service range is limited as follows, see Fig. 18:

Line 8:

Represents the overload operation limitations.

The area between lines 4, 5, 7 and the dashed line 8 in Fig. 18 is available for overload running for limited periods only (1 hour per 12 hours).

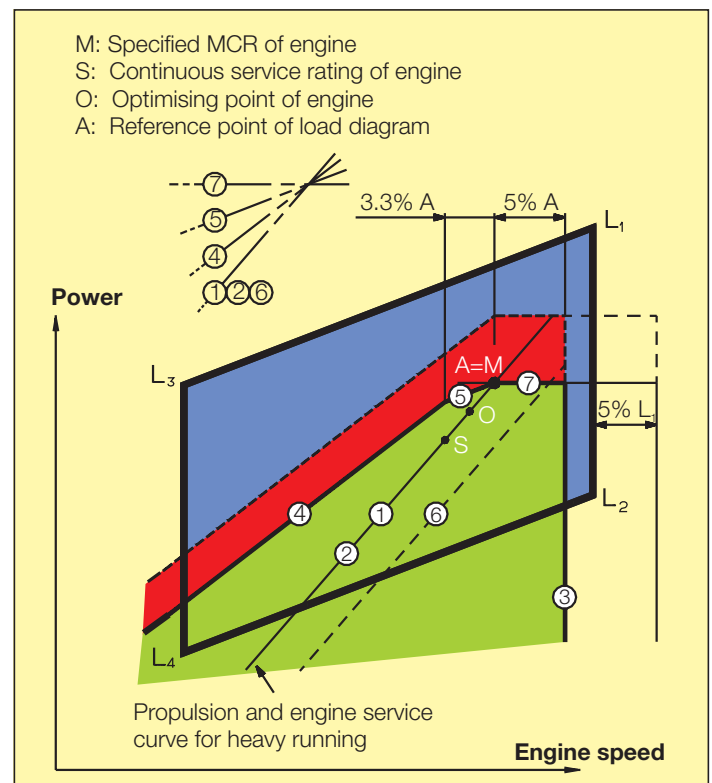
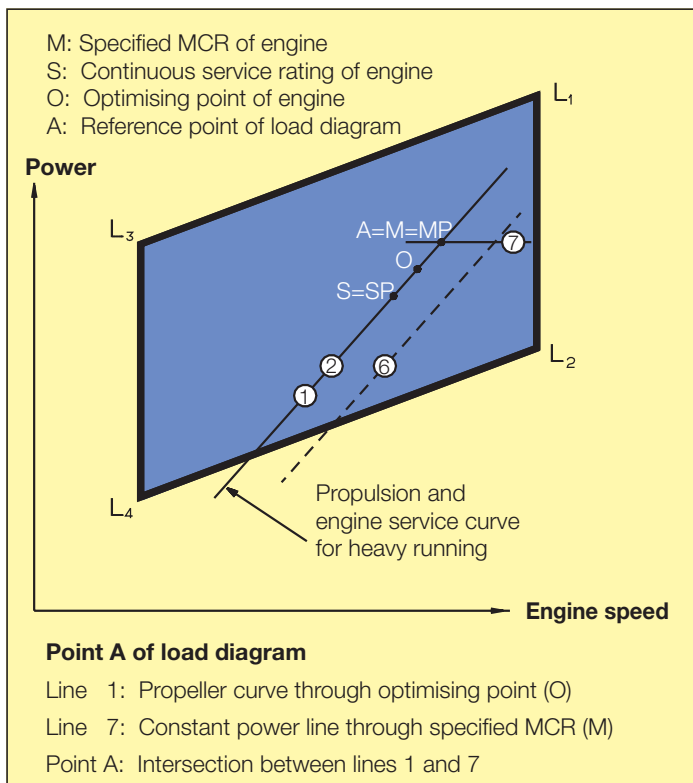

Fig. 19a: Example 1 with FPP – engine layout without SG (normal case)

Fig. 19b: Example 1 with FPP – load diagram without SG (normal case)

Electronic governor with load limitation
 In order to safeguard the diesel engine against thermal and mechanical overload, the approved electronic governors include the following two limiter functions:

- **Torque limiter**

The purpose of the torque limiter is to ensure that the limitation lines of the load diagram are always observed. The torque limiter algorithm compares the calculated fuel pump index (fuel amount) and the actually measured engine speed with a reference limiter curve giving the maximum allowable fuel pump index at a given engine speed. If the calculated fuel pump index is above this curve, the resulting fuel pump index will be reduced correspondingly.

The reference limiter curve is to be adjusted so that it corresponds to the limitation lines of the load diagram.

- **Scavenge air pressure limiter**

The purpose of the scavenge air

pressure limiter is to ensure that the engine is not being overfuelled during acceleration, as for example during manoeuvring.

The scavenge air pressure limiter algorithm compares the calculated fuel pump index and measured scavenge air pressure with a reference limiter curve giving the maximum allowable fuel pump index at a given scavenge air pressure. If the calculated fuel pump index is above this curve, the resulting fuel pump index will be reduced correspondingly.

The reference limiter curve is to be adjusted to ensure that sufficient air will always be available for a good combustion process.

Recommendation

Continuous operation without a time limitation is allowed only within the area limited by lines 4, 5, 7 and 3 of the load diagram. For fixed pitch propeller operation in calm weather with loaded

ship and clean hull, the propeller/engine may run along or close to the propeller design curve 6.

After some time in operation, the ship's hull and propeller will become fouled, resulting in heavier running of the propeller, i.e. the propeller curve will move to the left from line 6 towards line 2, and extra power will be required for propulsion in order to maintain the ship speed.

At calm weather conditions the extent of heavy running of the propeller will indicate the need for cleaning the hull and, possibly, polishing the propeller.

The area between lines 4 and 1 is available for operation in shallow water, heavy weather and during acceleration, i.e. for non-steady operation without any actual time limitation.

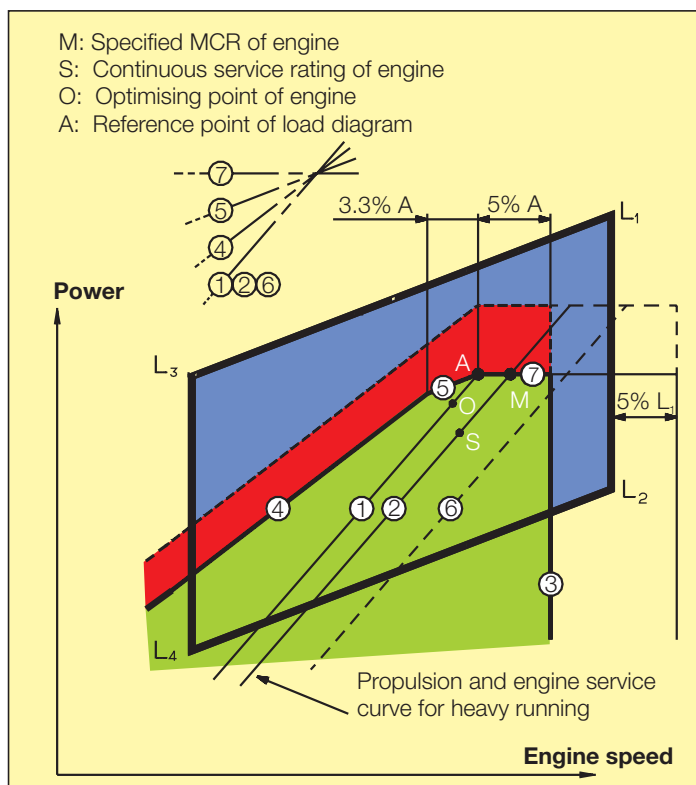
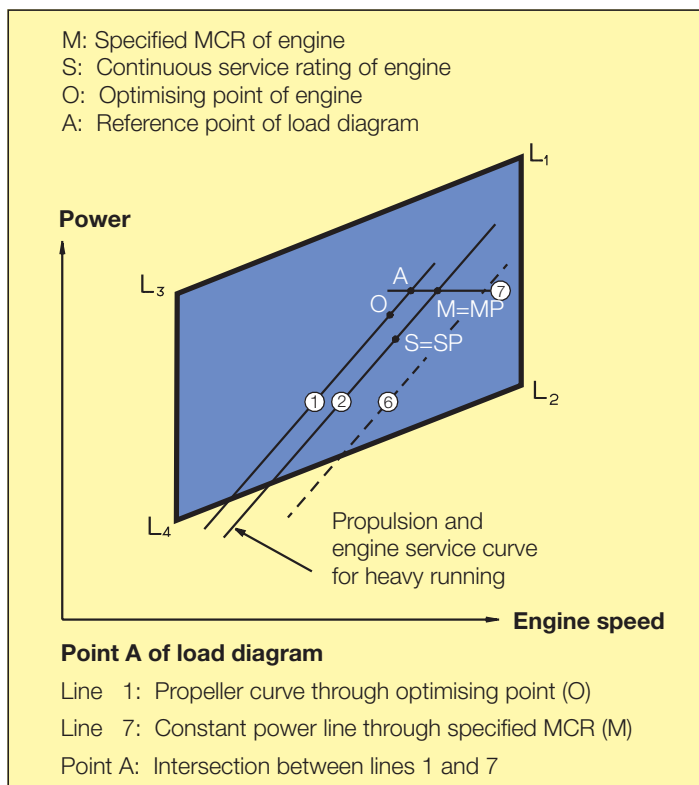

Fig. 20a: Example 2 with FPP – engine layout without SG (special case)

Fig. 20b: Example 2 with FPP – load diagram without SG (special case)

The recommended use of a relatively high light running factor for design of the propeller will involve that a relatively higher propeller speed will be used for layout design of the propeller. This, in turn, may involve a minor reduction of the propeller efficiency, and may possibly cause the propeller manufacturer to abstain from using a large light running margin. However, this reduction of the propeller efficiency caused by the large light running factor is actually relatively insignificant compared with the improved engine performance obtained when sailing in heavy weather and/or with fouled hull and propeller.

Use of layout and load diagrams - examples

In the following, four different examples based on fixed pitch propeller (FPP) and one example based on controllable pitch propeller (CPP) are given in order to illustrate the flexibility of the layout and load diagrams.

In this respect the choice of the optimising point *O* has a significant influence.

Examples with fixed pitch propeller

Example 1:
Normal running conditions, without shaft generator

Normally, the optimising point *O*, and thereby the engine layout curve 1, will be selected on the engine service curve 2 (for heavy running), as shown in Fig. 19a.

Point *A* is then found at the intersection between propeller curve 1 (2) and the constant power curve through *M*, line 7. In this case, point *A* will be equal to point *M*.

Once point *A* has been found in the layout diagram, the load diagram can be drawn, as shown in Fig. 19b, and hence the actual load limitation lines of the diesel engine may be found.

Example 2:
Special running conditions, without shaft generator

When the ship accelerates, the propeller will be subjected to an even larger load than during free sailing. The same applies when the ship is subjected to an extra resistance as, for example, when sailing against heavy wind and sea with *large wave resistance*.

In both cases, the engine's operating point will be to the left of the normal operating curve, as the propeller will run heavily.

In order to avoid exceeding the left-hand limitation line 4 of the load diagram, it may, in certain cases, be necessary to limit the acceleration and/or the propulsion power.

If the expected trade pattern of the ship is to be in an area with frequently appearing heavy wind and sea and

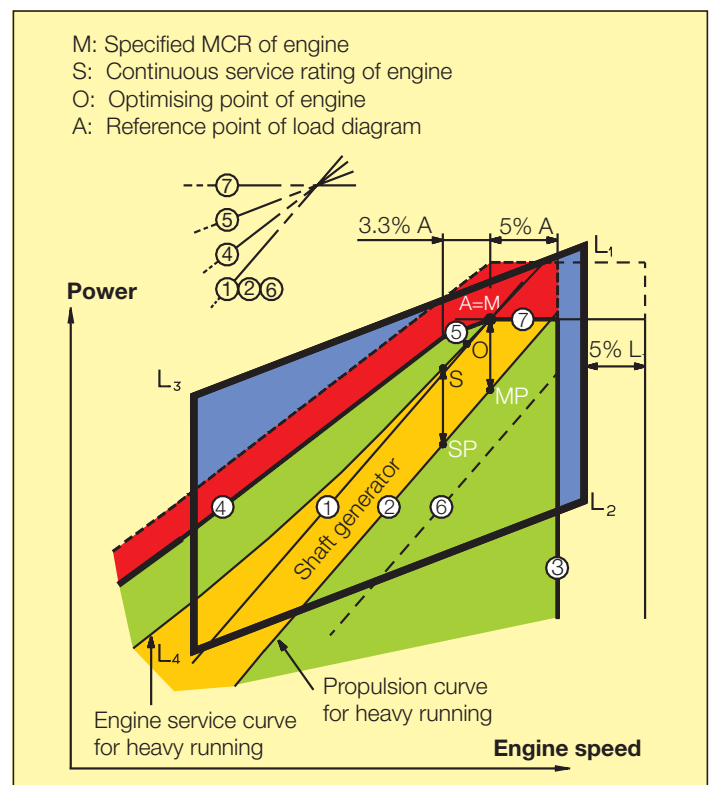
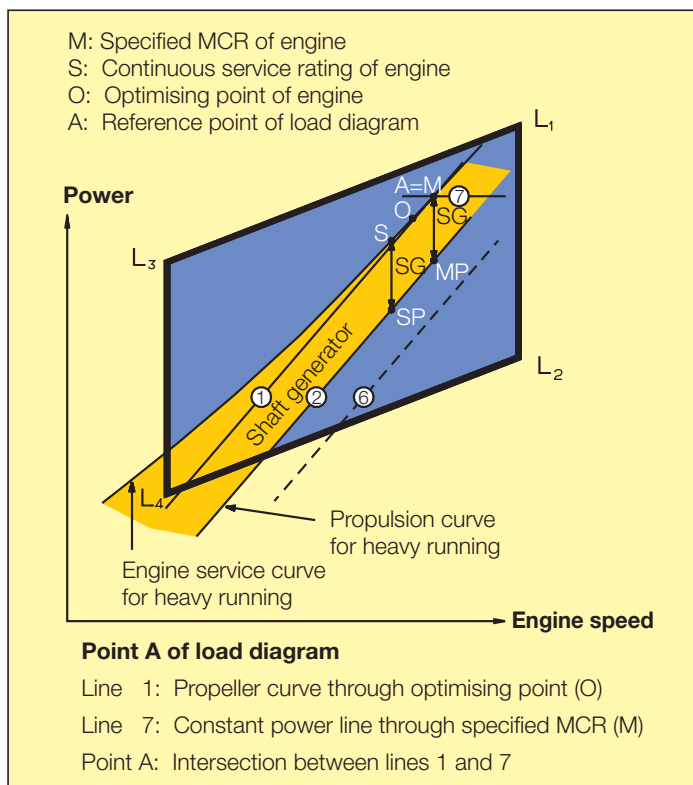

Fig. 21a: Example 3 with FPP – engine layout with SG (normal case)

Fig. 21b: Example 3 with FPP – load diagram with SG (normal case)

large wave resistance, it can, therefore, be an advantage to design/move the load diagram more towards the left.

The latter can be done by moving the engine's optimising point *O* – and thus the propeller curve 1 through the optimising point – towards the left. However, this will be at the expense of a slightly increased specific fuel oil consumption.

An example is shown in Figs. 20a and 20b. As will be seen in Fig. 20b, and compared with the normal case shown in Example 1 (Fig. 19b), the left-hand limitation line 4 is moved to the left, giving a wider margin between lines 2 and 4, i.e. a larger light running factor has been used in this example.

Example 3:
Normal case, with shaft generator

In this example a shaft generator (SG) is installed, and therefore the service power of the engine also has to incorporate the extra shaft power required

for the shaft generator's electrical power production.

In Fig. 21a, the engine service curve shown for heavy running incorporates this extra power.

The optimising point *O*, and thereby the engine layout curve 1, will normally be chosen on the propeller curve (~ engine service curve) through point *M*.

Point *A* is then found in the same way as in example 1, and the load diagram can be drawn as shown in Fig. 21b.

Example 4:
Special case, with shaft generator

Also in this special case, a shaft generator is installed but, unlike in Example 3, now the specified MCR for propulsion *MP* is placed at the top of the layout diagram, see Fig. 22a. This involves that the intended specified MCR of the engine (Point *M'*) will be placed outside the top of the layout diagram.

One solution could be to choose a diesel engine with an extra cylinder, but another and cheaper solution is to reduce the electrical power production of the shaft generator when running in the upper propulsion power range.

If choosing the latter solution, the required specified MCR power of the engine can be reduced from point *M'* to point *M* as shown in Fig. 22a. Therefore, when running in the upper propulsion power range, a diesel generator has to take over all or part of the electrical power production.

However, such a situation will seldom occur, as ships rather infrequently operate in the upper propulsion power range. In the example, the optimising point *O* has been chosen equal to point *S*, and line 1 may be found.

Point *A*, having the highest possible power, is then found at the intersection of line *L₁-L₃* with line 1, see Fig. 22a, and the corresponding load diagram is

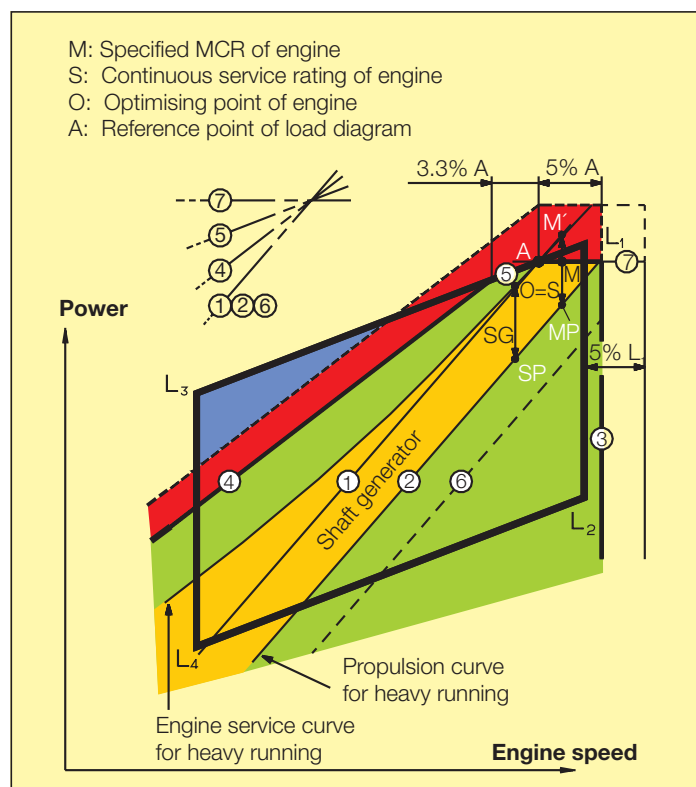
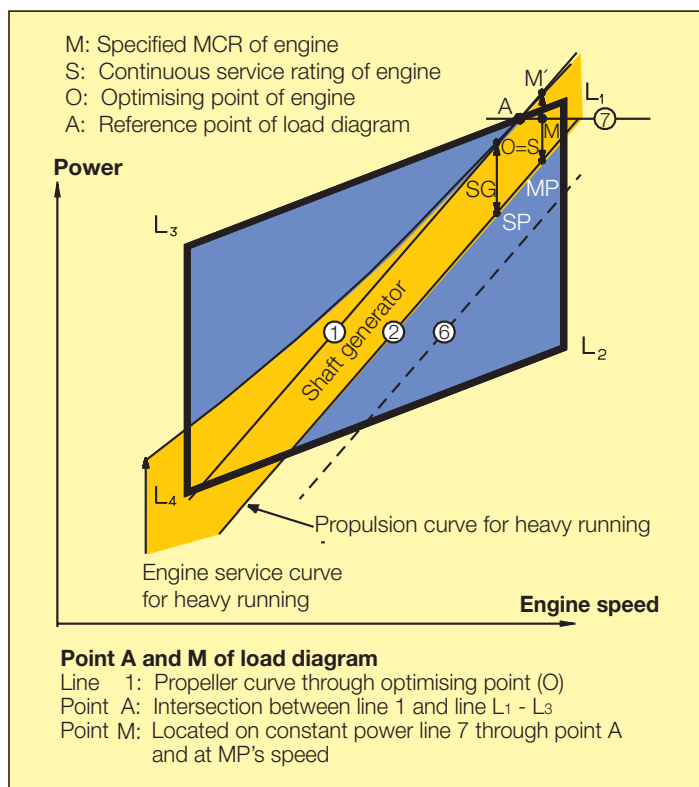

Fig. 22a: Example 4 with FPP – engine layout with SG (special case)

Fig. 22b: Example 4 with FPP – load diagram with SG (special case)

drawn in Fig. 22b. Point *M* is found on line 7 at *MP*'s speed.

Example with controllable pitch propeller

Example 5:
With or without shaft generator

Layout diagram – without shaft generator

If a controllable pitch propeller (CPP) is applied, the combinator curve (of the propeller with optimum propeller efficiency) will normally be selected for loaded ship including sea margin.

For a given propeller speed, the combinator curve may have a given propeller pitch, and this means that, like for a fixed pitch propeller, the propeller may be heavy running in heavy weather.

Therefore, it is recommended to use a light running combinator curve (the dotted curve), as shown in Fig. 23, to obtain an increased operating margin for the diesel engine in heavy weather to the load limits indicated by curves 4 and 5.

Layout diagram – with shaft generator

The hatched area in Fig. 23 shows the recommended speed range between 100% and 96.7% of the specified MCR speed for an engine with shaft generator running at constant speed.

The service point *S* can be located at any point within the hatched area.

The procedure shown in Examples 3 and 4 for engines with FPP can also be

applied for engines with CPP running on a combinator curve.

The optimising point *O* for engines with VIT can be chosen on the propeller curve 1 through point *A = M* with an optimised power from 85 to 100% of the specified MCR as mentioned before in the section dealing with optimising point *O*.

Load diagram

Therefore, when the engine's specified MCR point *M* has been chosen including engine margin, sea margin and the power for a shaft generator, if installed, point *M* can be used as point *A* of the load diagram, which can then be drawn.

The position of the combinator curve ensures the maximum load range within the permitted speed range for engine operation, and it still leaves a reasonable margin to the load limits indicated by curves 4 and 5.

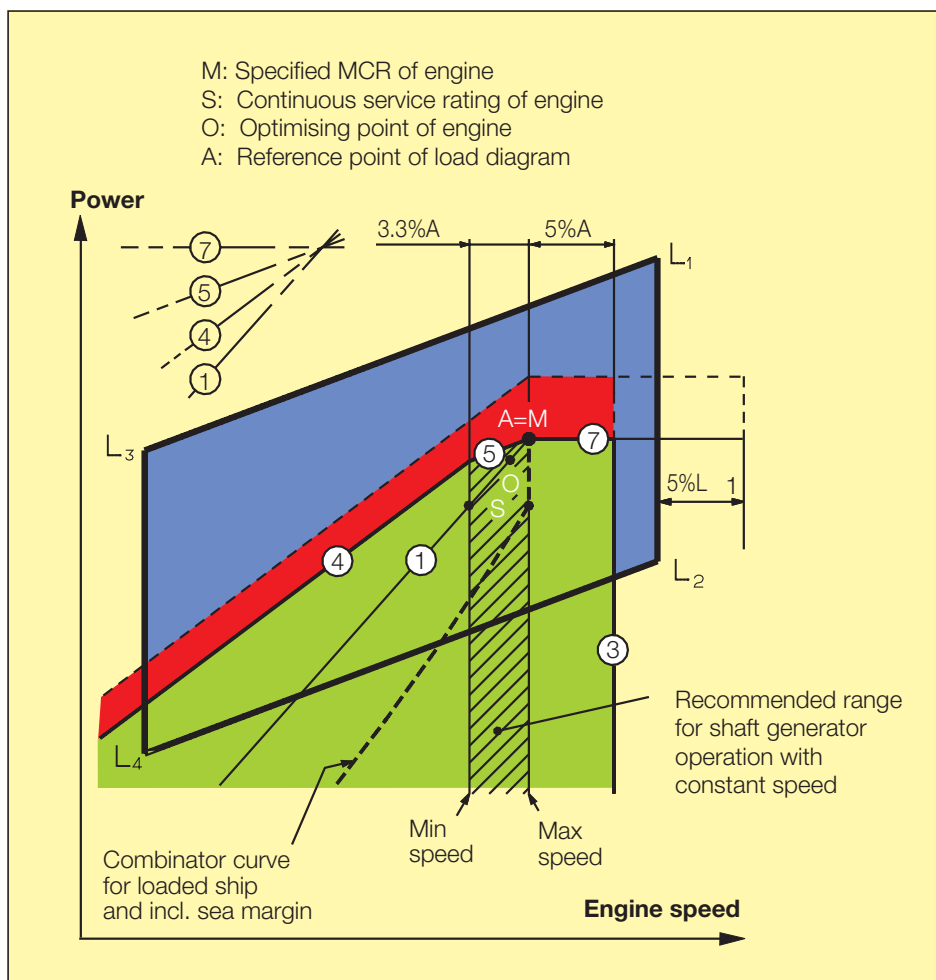

Fig. 23: Example 5 with CPP – with or without shaft generator

Influence on engine running of different types of ship resistance – plant with FP-propeller

In order to give a brief summary regarding the influence on the fixed pitch propeller running and main engine operation of different types of ship resistance, an arbitrary example has been chosen, see the load diagram in Fig. 24.

The influence of the different types of resistance is illustrated by means of corresponding service points for propulsion having the same propulsion power, using as basis the propeller design point *PD*, plus 15% extra power.

Propeller design point *PD*

The propeller will, as previously described, normally be designed according to a specified ship speed *V* valid for loaded ship with clean hull and calm weather conditions. The corresponding engine speed and power combination is shown as point *PD* on propeller curve 6 in the load diagram, Fig. 24.

Increased ship speed, point *S0*

If the engine power is increased by, for example, 15%, and the loaded ship is still operating with a clean hull and in calm weather, point *S0*, the ship speed

V and engine speed n will increase in accordance with the propeller law (more or less valid for the normal speed range):

$$V_{S0} = V \times \sqrt[3]{1.15} = 1.041 \times V$$

$$n_{S0} = n \times \sqrt[3]{1.15} = 1.048 \times n$$

Point $S0$ will be placed on the same propeller curve as point PD .

Sea running with clean hull and 15% sea margin, point S_2

Conversely, if still operating with loaded ship and clean hull, but now with extra

resistance from heavy seas, an extra power of, for example, 15% is needed in order to maintain the ship speed V (15% sea margin).

As the ship speed $V_{S2} = V$, and if the propeller had no slip, it would be expected that the engine (propeller) speed would also be constant. However, as the water does yield, i.e. the propeller has a slip, the engine speed will increase and the running point $S2$ will be placed on a propeller curve 6.2 very close to $S0$, on propeller curve 6. Propeller curve 6.2 will possibly represent an approximate 0.5% heavier running propeller than curve 6.

Depending on the ship type and size, the heavy running factor of 0.5% may be slightly higher or lower.

For a resistance corresponding to about 30% extra power (30% sea margin), the corresponding relative heavy running factor will be about 1%.

Sea running with fouled hull, and heavy weather, point SP

When, after some time in service, the ship's hull has been fouled, and thus becomes more rough, the wake field will be different from that of a smooth ship (clean hull).

A ship with a fouled hull will, consequently, be subject to an extra resistance which, due to the changed wake field, will give rise to a heavier running propeller than experienced during bad weather conditions alone. When also incorporating some average influence of heavy weather, the propeller curve for loaded ship will move to the left, see propeller curve 2 in the load diagram in Fig. 24. This propeller curve, denoted fouled hull and heavy weather for a loaded ship, is about 5% heavy running compared to the clean hull and calm weather propeller curve 6.

In order to maintain an ample air supply for the diesel engine's combustion, which imposes a limitation on the maximum combination of torque and speed, see curve 4 of the load diagram, it is normal practice to match the diesel engine and turbo-

PD: Propeller design point, clean hull and calm weather

Continuous service rating for propulsion with a power equal to 90% specified MCR, based on:

S0: Clean hull and calm weather, loaded ship

S1: Clean hull and calm weather, ballast (trial)

S2: Clean hull and 15% sea margin, loaded ship

SP: Fouled hull and heavy weather, loaded ship

S3: Very heavy sea and wave resistance

Engine shaft power % of A

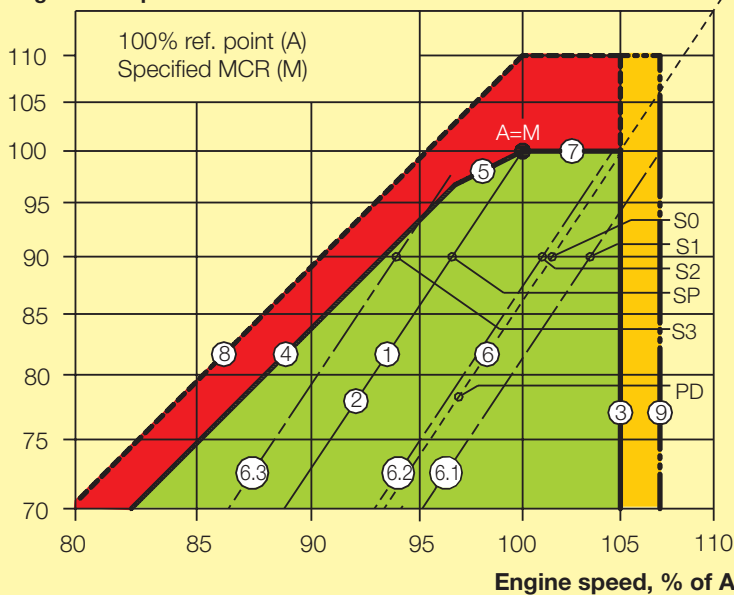

Line 1: Propeller curve through point $A=M$, layout curve for engine

Line 2: Heavy propeller curve, fouled hull and heavy weather, loaded ship

Line 6: Light propeller curve, clean hull and calm weather, loaded ship, layout curve for propeller

Line 6.1: Propeller curve, clean hull and calm weather, ballast (trial)

Line 6.2: Propeller curve, clean hull and 15% sea margin, loaded ship

Line 6.3: Propeller curve, very heavy sea and wave resistance

Fig. 24: Influence of different types of ship resistance on the continuous service rating

charger etc. according to a propeller curve 1 of the load diagram, equal to the heavy propeller curve 2.

Instead of point S2, therefore, point SP will normally be used for the engine layout by referring this service propulsion rating to, for example, 90% of the engine's specified MCR, which corresponds to choosing a 10% engine margin.

In other words, in the example the propeller's design curve is about 5% light running compared with the propeller curve used for layout of the main engine.

Running in very heavy seas with heavy waves, point S3

When sailing in very heavy sea against, with heavy waves, the propeller can be 7-8% heavier running (and even more) than in calm weather, i.e. at the same propeller power, the rate of revolution may be 7-8% lower.

For a propeller power equal to 90% of specified MCR, point S3 in the load diagram in Fig. 24 shows an example of such a running condition.

In some cases in practice with strong wind against, the heavy running has proved to be even greater and even to be found to the left of the limitation line 4 of the load diagram.

In such situations, to avoid slamming of the ship and thus damage to the stem and racing of the propeller, the ship speed will normally be reduced by the navigating officers on watch.

Ship acceleration and operation in shallow waters

When the ship accelerates and the propeller is being subjected to a larger load than during free sailing, the effect on the propeller may be similar to that illustrated by means of point S3 in the load diagram, Fig. 24. In some cases in practice, the influence of acceleration on the heavy running has proved to be even greater. The same conditions are valid for running in shallow waters.

Sea running at trial conditions, point S1
Normally, the clean hull propeller curve 6 will be referred to as the trial trip propeller curve. However, as the ship is

seldom loaded during sea trials and more often is sailing in ballast, the actual propeller curve 6.1 will be more light running than curve 6.

For a power to the propeller equal to 90% specified MCR, point S1 on the load diagram, in Fig. 24, indicates an example of such a running condition. In order to be able to demonstrate operation at 100% power, if required, during sea trial conditions, it may in some cases be necessary to exceed the propeller speed restriction, line 3, which during trial conditions may be allowed to be extended to 107%, i.e. to line 9 of the load diagram.

Influence of ship resistance on combinator curves – plant with CP-propeller

This case is rather similar with the FP-propeller case described above, and therefore only briefly described here.

The CP-propeller will normally operate on a given combinator curve, i.e. for a given propeller speed the propeller pitch is given (not valid for constant propeller speed). This means that heavy running operation on a given propeller speed will result in a higher power operation, as shown in the example in Fig. 25.

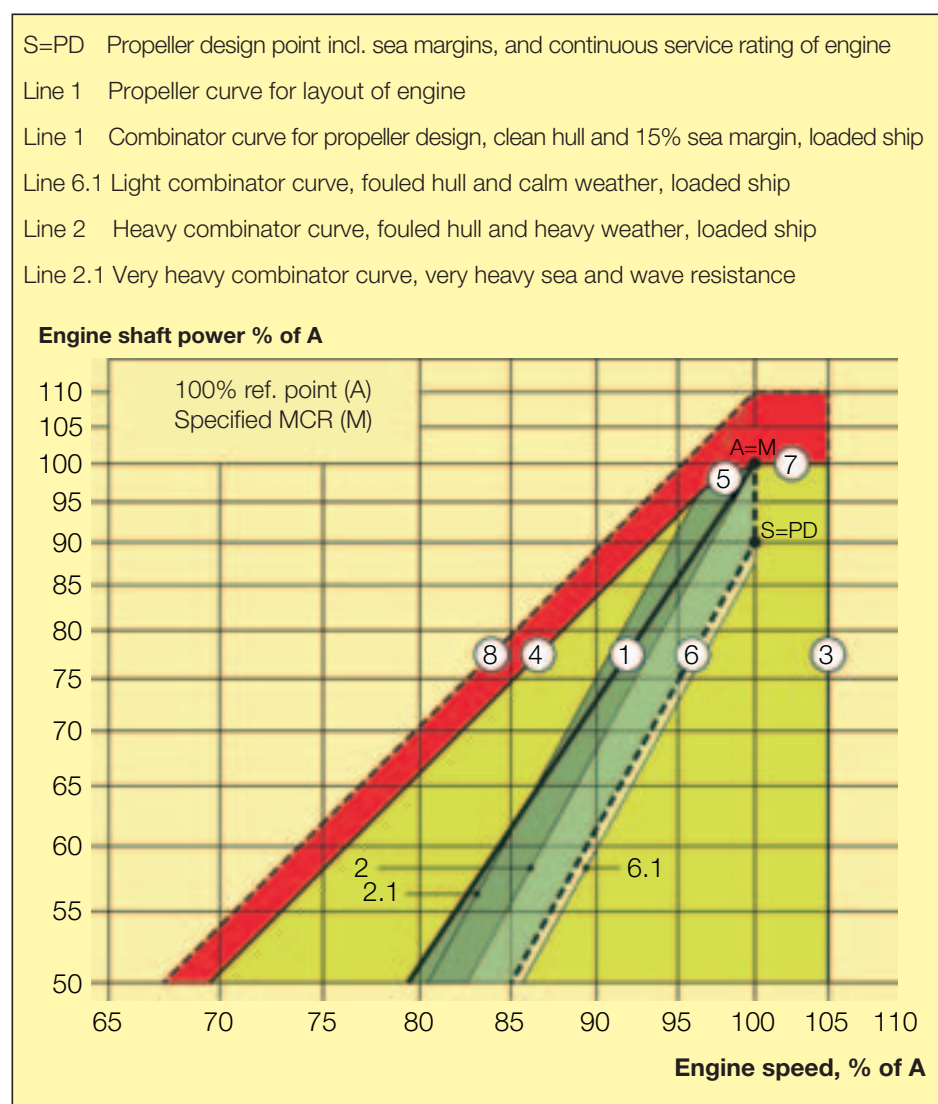

Fig. 25: Influence of ship resistance on combinator curves for CP-propeller

Closing Remarks

In practice, the ship's resistance will frequently be checked against the results obtained by testing a model of the ship in a towing tank. The experimental tank test measurements are also used for optimising the propeller and hull design.

When the ship's necessary power requirement, including margins, and the propeller's speed (rate of revolution) have been determined, the correct main engine can then be selected, e.g. with the help of MAN B&W Diesel's computer-based engine selection programme.

In this connection the interaction between ship and main engine is extremely important, and the placing of the engine's load diagram, i.e. the choice of engine layout in relation to the engine's (ship's) operational curve, must be made carefully in order to achieve the optimum propulsion plant. In order to avoid overloading of the main engine for excessive running conditions, the installation of an electronic governor with load control may be useful.

If a main engine driven shaft generator – producing electricity for the ship – is installed, the interaction between ship and main engine will be even more complex. However, thanks to the flexibility of the layout and load diagrams for the MAN B&W engines, a suitable solution will nearly always be readily at hand.

References

- [1] Technical discussion with Keld Kofoed Nielsen, Burmeister & Wain Shipyard, Copenhagen
- [2] Ship Resistance H.E. Guldhammer and Sv. Aa. Harvald, 1974
- [3] Resistance and Propulsion of Ships, Sv. Aa. Harvald, 1983
- [4] Paint supplier "International Coatings Ltd.", 2003
- [5] Fartygspropellrar och Fartygs Framdrift, Jan Tornblad, KaMeWa Publication, 1985
- [6] Prediction of Power of Ships Sv. Aa. Harvald, 1977 and 1986
- [7] Propulsion of Single-Screw Ships Sv. Aa. Harvald & J.M. Hee, 1981

Furthermore, we recommend:

